

BME 301

- There are 5 questions to be answered.
- There is a 6th question for extra credit.
- Write neatly and clearly.

Exam 1

1. Action Potential

- a) What is the Action Potential and where does it occur?
- b) What causes the Action Potential?
- c) What effects does Action Potential have on muscles and on nerves.
- d) Sketch the Action Potential, show where the cell transitions occur, and what happens to muscles during these transitions.

2. ECG

- a) How does the Action Potential affect the heart chambers and blood flow?
- b) Discuss the key phases of the ECG where the heart chambers are active and describe what happens to the heart chambers and blood flow during these phases. What controls this activity?

Exam 1

3. Electrical Basics
 - a) Describe the key physical electrical entities that support an electrical circuit.
 - b) Describe the rules for these electrical entities to adhere to.
 - c) Describe the **5 linear** electrical circuit **elements** and how they function in a circuit. How many of these elements are needed for an electrical circuit to operate.
 - d) How must these these elements be connected to support an electrical circuit? What must not be the connection method?

Exam 1

4. Simple Circuitry

- a) In the circuit in part b) what elements are in series and what elements are in parallel with respect to terminals a and b.
- b) Calculate the resistance of the following circuit with respect to terminals a-b where $R_1=R_2=R_4=R_5=3.75$ ohms, $R_3=R_6=15$ ohm , and $R_7=R_8=R_9=5$ ohms .

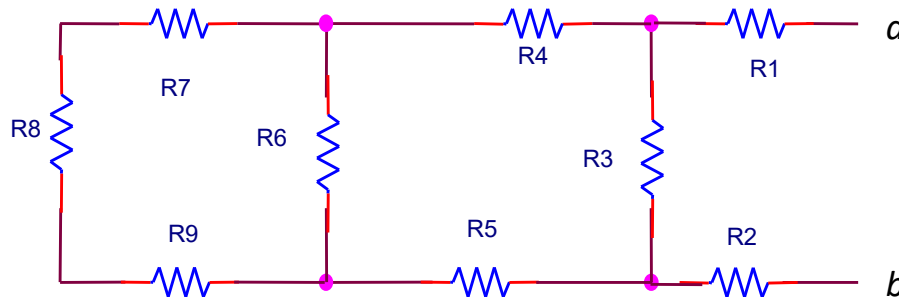

- c) Determine the capacitance of the following circuit with respect to terminals a-b.

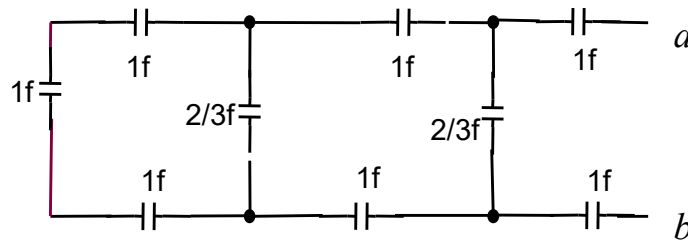

Exam 1

5. Complex circuits

Find the impedance in the simplest polar form of the following circuits with respect to terminals a-

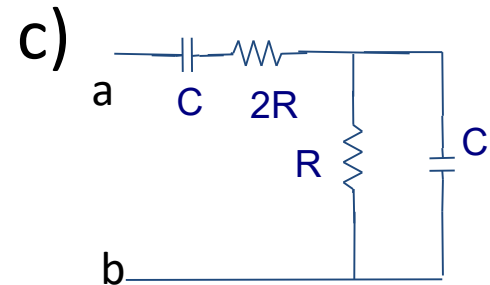
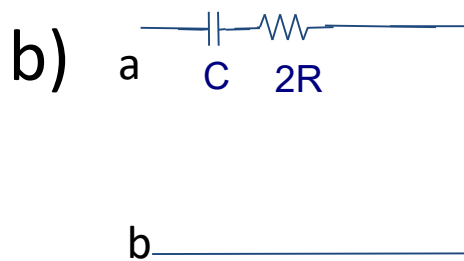
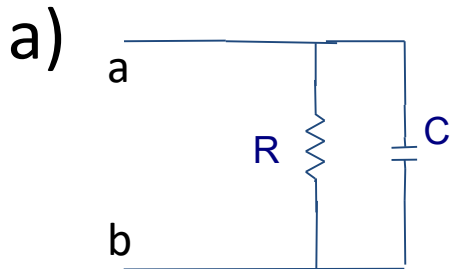

Exam 1

6. Extra Credit: Charging/Discharging

- Describe what happens when the switch is in position 1
- Describe what happens when the switch is in position 2
- The switch is in position 1 for 5msec and it is determined that the voltage across the capacitor reaches approximately 63% of its final value. What is the value of the capacitor?
- The switch is moved to position 2. What should the value of R_2 be for the capacitor to discharge its voltage 1000 times faster than when it charges?

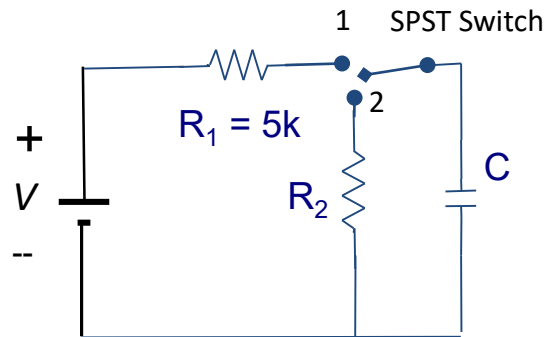

Exam 1 Answers

1. Action Potential

a) What is the Action Potential and where does it occur?

A change in the voltage across cell membrane.

b) What causes the Action Potential?

A stimulus

c) What affects does Action Potential have on muscles and on nerves.

For muscles it causes them to contract and relax. For Nerves, sends a “signal” down the axion.

d) Sketch the Action Potential, show where the cell transitions occur, and what happens to muscles during these transitions.

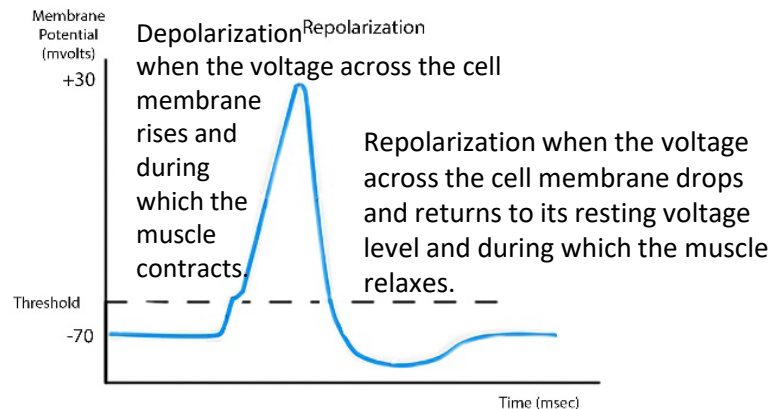

Exam 1 Answers

2. ECG

- a) How does the Action Potential affect the heart chambers and blood flow?

The Action Potential causes the chambers to contract and relax causing oxygenated blood to flow into the body and deoxygenated blood to flow into the lungs to receive oxygen.

Exam 1 Answers

2. ECG

- b) Discuss the key phases of the ECG where the heart chambers are active and describe what happens to the heart chambers and blood flow during these phases. What controls this activity?

During the P wave the atria contract (during AP depolarization) sending blood to the ventricles. The right atrium receives deoxygenated blood and then sends it to the right ventricle. The left atrium receives oxygenated blood to the left ventricle.

During the QRS complex the right ventricle contracts (during AP depolarization) and sends deoxygenated blood to the lungs obtain oxygen. The left ventricle contracts (during AP depolarization) and sends oxygenated blood to the body. During this time the atrium relax (during AP repolarization) but since the signal from the ventricles is large the atrium depolarization signal is not visible.

During the T wave, the ventricles relax (during AP repolarization) .

This entire process is started by the Sinoatrial (SA) node causes an Action Potential at the muscles of the atria to contract (the stimulus to depolarize) and sends a delayed signal to Atrioventricular (AV) node which causes an Action Potential at the muscles of the ventricles to contract (the stimulus to depolarize).

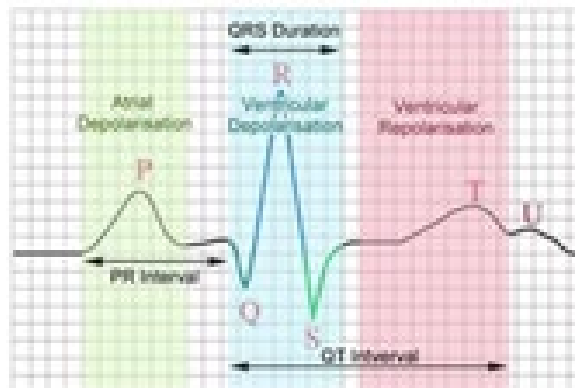

Exam 1 Answers

3. Electrical Basics

a) Describe the key physical electrical entities that support an electrical circuit.

The key electrical entities are current, the movement or flow of charges and voltage, the force needs to move these charges.

b) Describe the rules for these electrical entities to adhere to

Kirchhoff's voltage law (sum of the voltages around a loop must be equal to zero) and current law (sum of the currents entering or leaving a node must be equal to zero) .

Exam 1 Answers

3. Electrical Basics

- c) Describe the **5 linear** electrical circuit **elements** and how they function in a circuit. How many of these elements are needed for an electrical circuit to operate.

The 5 linear electrical circuit elements are grouped into active and passive elements.

The active elements are voltage sources and current sources which provides the energy/power to the passive elements.

The passive elements are the resistor which dissipates the energy into heat, the inductor which stores the energy as a magnetic field and the capacitor which stores the energy as an electric field.

There needs to be at least one active element and one passive element

Exam 1 Answers

3. Electrical Basics

- d) How must these these elements be connected to support an electrical circuit? What must not be the connection method.

The active and passive elements must be connected to allow for a return path for current to flow from the active element, through the passive elements and return to active elements. This is called a closed circuit.

An open circuit where there is no return path does not support current flow.

Exam 1 Answers

4. Simple Circuitry

- a) In the circuit in part b) what elements are in series and what elements are in parallel with respect to terminals a and b.

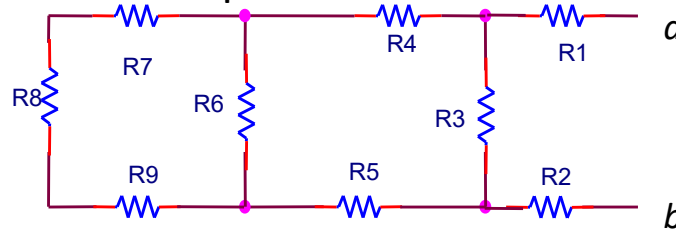

R7, R8, and R9 are all in series. Call this R_A . R_A is in parallel with R6. Call this R_B . R_B is in series with R4 and R5. Call this R_C . R_C is in parallel with R3. Call this R_D . Finally R_D is in series with R1 and R2. This is R_{ab} .

Exam 1 Answers

4. Simple Circuitry

R7, R8, and R9 are all in series. Call this R_A . R_A is in parallel with R6. Call this R_B . R_B is in series with R4 and R5. Call this R_C . R_C is in parallel with R3. Call this R_D . Finally R_D is in series with R1 and R2. This is R_{ab} .

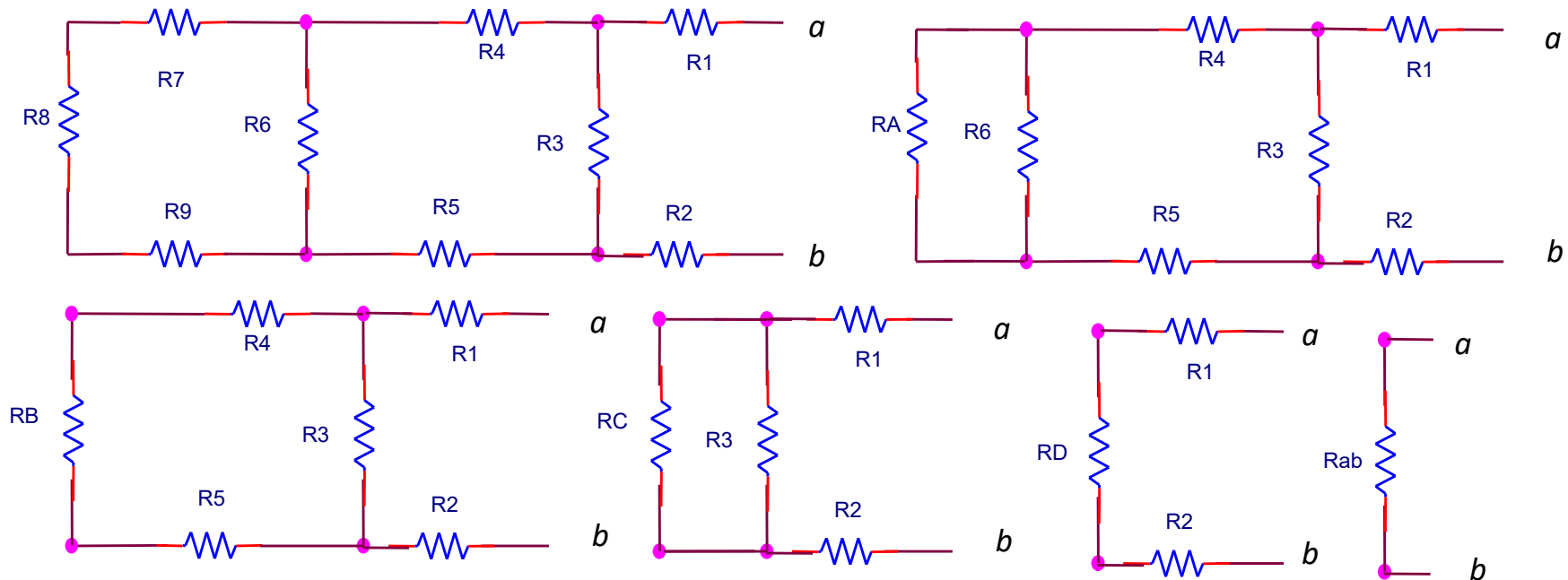

Exam 1 Answers

4. Simple Circuitry

- a) Calculate the resistance of the following circuit with respect to terminals a-b where $R_1=R_2=R_4=R_5=3.75$ ohms, $R_3=R_6=15$ ohm , and $R_7=R_8=R_9=5$ ohms .

$$R_A = R_1 + R_2 + R_3 = 5 + 5 + 5 = 15$$

$$R_B = R_A \parallel R_6 = 15 \parallel 15 = 7.5$$

$$R_C = R_B + R_4 + R_5 = 7.5 + 3.75 + 3.75 = 15$$

$$R_D = R_C \parallel R_3 = 15 \parallel 15 = 7.5$$

$$R_{ab} = R_D + R_1 + R_2 = 7.5 + 3.75 + 3.75 = 15$$

Exam 1 Answers

4. Simple Circuitry

- c) Determine the capacitance of the following circuit with respect to terminals a-b.

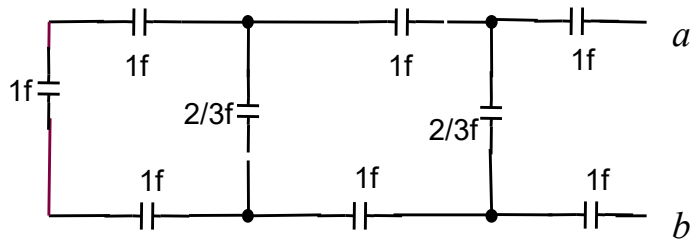

$$CA = 1 \text{ in series } 1 \text{ in series } 1 = \frac{1}{\frac{1}{1} + \frac{1}{1} + \frac{1}{1}} = \frac{1}{3}$$

$$CB = CA \parallel \frac{2}{3} = \frac{1}{\frac{3}{1} + \frac{3}{2}} = \frac{2}{5}$$

$$CC = CB \text{ in series } 1 \text{ in series } 1 = \frac{1}{\frac{1}{\frac{2}{5}} + \frac{1}{1} + \frac{1}{1}} = \frac{1}{\frac{5}{2} + 1 + 1} = \frac{1}{\frac{9}{2}} = \frac{2}{9}$$

$$CD = CC \parallel \frac{2}{3} = \frac{2}{\frac{9}{2} + \frac{3}{2}} = \frac{2}{6} = \frac{1}{3}$$

$$Cab = CD \text{ in series } 1 \text{ in series } 1 = \frac{1}{\frac{1}{\frac{1}{3}} + \frac{1}{1} + \frac{1}{1}} = \frac{1}{3 + 1 + 1} = \frac{1}{5}$$

Exam 1 Answers

5. Complex circuits

Find the impedance in the simplest polar form of the following circuits with respect to terminals a-

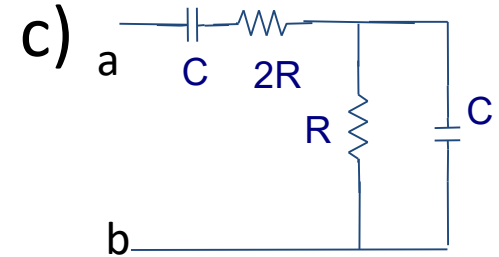
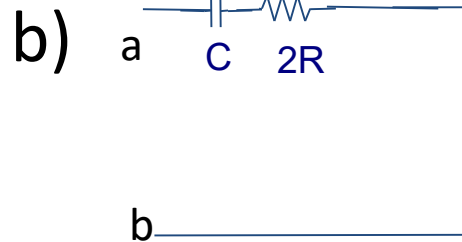
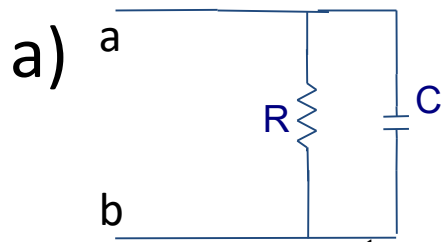

$$a) R \parallel \frac{1}{j\omega C} = \frac{R \frac{1}{j\omega C}}{R + \frac{1}{j\omega C}} = \frac{R}{1 + j\omega RC} = \frac{R}{\sqrt{1 + (\omega RC)^2} \angle \tan^{-1}(\omega RC)} = \frac{R}{\sqrt{1 + (\omega RC)^2}} \angle -\tan^{-1}(\omega RC)$$

$$b) 2R + \frac{1}{j\omega C} = \frac{1 + j\omega 2RC}{j\omega C} = \frac{\sqrt{1 + (\omega 2RC)^2} \angle \tan^{-1}(\omega 2RC)}{\omega C \angle \frac{\pi}{2}} = \frac{\sqrt{1 + (\omega 2RC)^2}}{\omega C} \angle [\tan^{-1}(\omega 2RC) - \frac{\pi}{2}]$$

Exam 1 Answers

5. Complex circuits

Find the impedance in the simplest polar form of the following circuits with respect to terminals a-b.

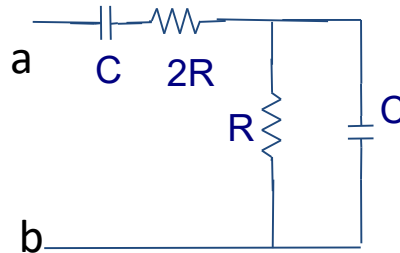

$$\begin{aligned}
 \text{c) } 2R + \frac{1}{j\omega C} + R \parallel \frac{1}{j\omega C} &= \frac{1+j\omega 2RC}{j\omega C} + \frac{R}{1+j\omega RC} = \frac{(1+j\omega 2RC)(1+j\omega RC) + j\omega RC}{j\omega C(1+j\omega RC)} = \frac{1+j\omega 3RC + 2(j\omega RC)^2 + j\omega RC}{j\omega C + (j\omega C)(j\omega RC)} \\
 &= \frac{1 - 2(\omega RC)^2 + j\omega 4RC}{-(\omega C)^2 R + j\omega C} \\
 &= \frac{\sqrt{(1 - 2(\omega RC)^2)^2 + (\omega 4RC)^2} \angle \tan^{-1}\left(\frac{\omega 4RC}{1 - (\omega 2RC)^2}\right)}{\sqrt{((\omega C)^2 R)^2 + (\omega C)^2} \angle \tan^{-1}\left(\frac{\omega C}{-(\omega C)^2 R}\right)} = \frac{\sqrt{(1 - 2(\omega RC)^2)^2 + (\omega 4RC)^2}}{\sqrt{((\omega C)^2 R)^2 + (\omega C)^2}} \angle \left[\tan^{-1}\left(\frac{\omega 4RC}{1 - (\omega 2RC)^2}\right) - \tan^{-1}\left(\frac{\omega C}{-(\omega C)^2 R}\right) \right]
 \end{aligned}$$

Exam 1 Answers

6. Extra Credit

a) Describe what happens when the switch is in position 1
The Capacitor will charge through R_1 .

b) Describe what happens when the switch is in position 2
The Capacitor will discharge through R_2 when the capacitor has charge stored across its plates.

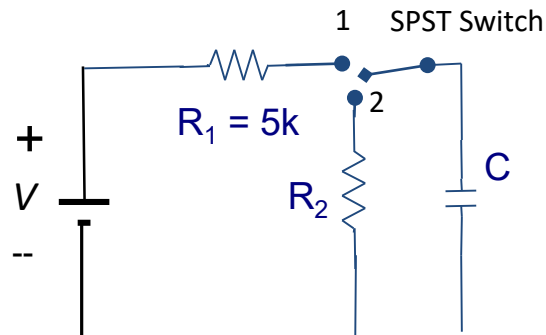

Exam 1 Answers

6. Extra Credit

- c) The switch is in position 1 for 5msec and it is determined that the voltage across the capacitor reaches approximately 63% of its final value. What is the value of the capacitor?

The voltage for a charging capacitor is

$$V_C(t) = V(1 - e^{-\frac{t}{RC}}) = V(1 - e^{-\frac{t}{\tau}}) \text{ where } \tau \text{ is the time constant } RC$$

And 63 percent is when $t_{63\%}$ is:

$$\frac{V(t_{63\%})}{V} = 0.63 = (1 - e^{-\frac{t_{63\%}}{\tau}})$$

$$0.37 = e^{-\frac{t_{63\%}}{\tau}} \Rightarrow \ln 0.37 \cong -1 = -\frac{t_{63\%}}{\tau}$$

$t_{63\%} = \tau$ or 1 time constant

$$\therefore \tau = RC = 5\text{msec} = 0.005$$

$$\therefore C = \frac{0.005}{5000} = 1\mu\text{f}$$

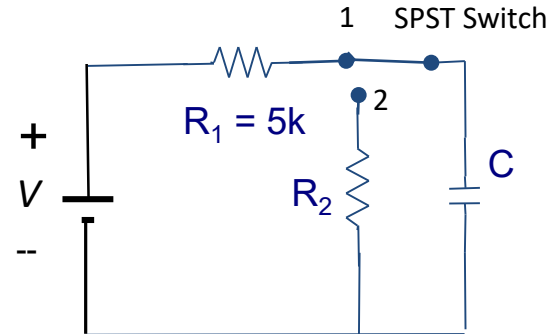

Exam 1 Answers

6. Extra Credit

- d) The switch is moved to position 2. What should the value of R_2 be for the capacitor to discharge its voltage 1000 times faster than when it charges?

$$1000 \text{ times faster would make the time constant} = \frac{0.005}{1000} = \frac{5 \times 10^{-3}}{10^3} = 5 \times 10^{-6} \text{ sec}$$

$$\therefore R_2 C = 5 \times 10^{-6} \Rightarrow R_2 = \frac{5 \times 10^{-6}}{1 \mu} = \frac{5 \times 10^{-6}}{1 \times 10^{-6}} = 5 \Omega$$

