

Clean Energy and Environment

Combating Climate Change by Hong Kong Professions



W.W.T. Fok, F.F. Wu, V.O.K. Li,
G. Yang, J. Zhong, D.Y.C. Leung,
M.K.H. Leung, Gambarota. L., Y. Deng,
W.C.H. Choy, K.T. Chau, L. Cheung, H. Ng,
C. Loo, K.S. Lui, K.T.H. Hui, L. F. Cheung,
P.W.T. Pong, J. Lam, C. Ng, P. Hills,
C.C. Ngan, T.K. Cheng, K.H. Lam



Clean Energy and Environment

Combating Climate Change by Hong Kong Researchers and Professionals

Published by:

Faculty of Engineering, The University of Hong Kong

Initiative on Clean Energy and Environment, The University of Hong Kong

Address:

5/F Haking Wong Building,

The University of Hong Kong,

Pokfulam Road,

Hong Kong Special Administrative Region, China

Copyright 2011 ©

Editor: Wilton W.T. Fok

Cover design: Ken K.Y. Law

Photographers: Eric H.H. Au Yeung, Lisa L. Xu

ISBN number: 978-988-15045-1-7

Authors

Chapter 1: Overview

Dr. Wilton Fok, Assistant Dean (Knowledge Exchange), Faculty of Engineering, HKU

Chapter 2: The Future Grid for Renewable Energy

Prof. Felix Wu, Convenor of Initiative on Clean Energy and Environment, HKU

Chapter 3: Sensor and Actuator Networks for Smart Grid

Prof. Victor O.K. Li, Associate Dean (Research), Faculty of Engineering, HKU

Dr. Guanghua Yang, Post Doctoral Fellow, Department of EEE, HKU

Chapter 4: Smart Grid for Renewable Energy

Dr. Jin Zhong, Associate Professor, Department of EEE, HKU

Chapter 5: Micro-wind Turbine System in Urban Environment

Prof. Dennis YC Leung, Professor, Department of Mechanical Engineering, HKU

Dr. Leung, M.K.H., School of Energy & Environment, City University of Hong Kong

Mr. Gambarota, L., Motorwave Group (Holding) Ltd.

Mr. Deng, Y., Department of Mechanical Engineering, HKU

Chapter 6: Thin Film Solar Cells

Dr. Wallace Choy, Assistant Professor, Department of EEE, HKU

Chapter 7: Electric Vehicles

Prof. K.T. Chau, Professor, Department of Electrical and Electronic Engineering, HKU

Chapter 8: Green Information Communication Technology

Dr. Lawrence Cheung, Principal Consultant, HK Productivity Council

Dr. Victor Ng Hon, Senior Consultant, HK Productivity Council

Mr. Clifford Loo, Consultant, HK Productivity Council

Chapter 9: Magnetism in clean energy and environment

Dr. K.S. Lui, Associate Professor, Department of EEE, HKU

Mr. Kelvin T. H. Hui, Department of EEE, HKU

Mr. L. F. Cheung, Department of EEE, HKU

Dr. Philip. W.T. Pong, Assistant Professor, Department of EEE, HKU

Chapter 10: Open Innovation for Environmental and Cleaner Energy Research

Dr. Jacqueline Lam, Kadoorie Institute, HKU

Dr. Clever Ng, Kadoorie Institute, HKU

Prof. Peter Hills, Director, Kadoorie Institute, HKU

Chapter 11: Case: Renewable Energy in the Town Island

Ir C.C. Ngan, Director, CLP Research Institute

T.K.Chan, R Ho, K.C. Cheng, Emmy Lee, CLP Research Institute

Chapter 12: Local Weather Effect on the Town Island PV system

T.K. Cheng, Department of Electrical and Electronic Engineering

Dr. Wilton Fok, Department of Electrical and Electronic Engineering

Chapter 13: Case: Hong Kong Schools Solar Education Programme

Dr. K.H. Lam, Honorary Lecturer, Department of EEE, HKU

Table of contents

1 Overview..... 21

Section 1: Energy Management

2 The Future Grid for Renewable Energy..... 27

2.1 Introduction 27

2.2 Modern Grid 29

2.3 Smart Grid of the Future..... 33

2.4 Conclusion 38

3 Sensor and Actuator Networks for Smart Grid..... 42

3.1 Introduction 42

3.2 SANET and Smart Grid..... 43

3.2.1 SANET 43

3.2.2 SANET Design Considerations 44

3.2.3 Smart Grid 45

3.2.4 Energy flow and information flow 46

3.3 SANET in Smart Grid 47

3.4 Applications of SANET in SG 47

3.4.1 RE Penetration 48

3.4.2 Grid monitoring and control (GMC) 48

3.4.3 Generation dispatch (GD) and demand-side management (DSM)..... 48

3.5 Actors of SANET in SG 49

3.5.1 Sensors in SG..... 49

3.5.2 Actuators in SG 51

3.5.3 Controllers and Control Logic in SG..... 52

3.5.4 Communication Network 52

3.6 Challenges of SANET in SG..... 53

3.6.1 Heterogeneity and distributed operation..... 53

3.6.2 Dynamics 53

3.6.3 Scalability 54

3.6.4 Flexibility..... 54

3.6.5 Energy-efficiency and cost-efficiency..... 54

- 3.7 Proposed Mechanisms 55
 - 3.7.1 Pervasive Service-Oriented Network (PERSON)..... 55
 - 3.7.2 Heterogeneous network platform (HNP)..... 55
 - 3.7.3 Service-oriented network (SON) 55
 - 3.7.4 SANET applications 56
- 3.8 Context-Aware Intelligent Control 56
- 3.9 Compressive sensing (CS)..... 56
- 3.10 Device Technologies 57
 - 3.10.1 Low power consumption design and power-harvesting technologies 57
 - 3.10.2 Modular and Compact design..... 58
- 3.11 Energy Management System at Customer Domain 58
- 3.12 Conclusion 60
- 4 Smart Grid for Renewable Energy 62
 - 4.1 Introduction 62
 - 4.2 Power Industry and Smart Grid 63
 - 4.3 Customers Demand Response in Smart Grid 65
 - 4.4 Renewable Energy Integration to Power Grid..... 66
 - 4.5 Future Control Center and ICT Applications 69
 - 4.6 Conclusions 71

Section 2: New Energy

- 5 Micro-wind Turbine System in Urban Environment 73
 - 5.1 Introduction 73
 - 5.2 Design of an innovative micro-wind turbine 75
 - 5.3 Factors to be considered in the design of a micro-wind turbine 76
 - 5.3.1 Tip speed ratio 77
 - 5.3.2 Effect of blade subtend-angle 77
 - 5.3.3 Effect of Solidity 79
 - 5.4 Micro-wind turbine system..... 79
 - 5.5 Conclusions 81
- 6 Thin Film Solar Cells..... 83

6.1	Types of Thin Film Solar Cells	83
6.1.1	Inorganic Thin Film Solar Cells	85
6.1.2	Photochemical thin film solar cells.....	86
6.1.3	Organic Thin Film Solar Cell	87

Section 3: Carbon Reduction

7	Electric Vehicles	94
7.1	Introduction	94
7.2	Energy Benefit.....	98
7.3	Environmental Benefit.....	101
7.4	HKU's Role	103
7.5	Research & Development.....	108
7.6	Vision	113
8	Green Information Communication Technology.....	115
8.1	Introduction of Green ICT	115
8.2	Advices on Green ICT through the two approaches and seven perspectives	116
8.2.1	Dematerialization and Waste Reduction	116
8.2.2	Process/Flow Control	118
8.2.3	Virtualization.....	119
8.2.4	ICT Facilities Energy Optimization.....	119
8.2.5	Eco-friendly Equipment Procurement.....	122
8.2.6	Environment Conscious Disposal.....	123
8.3	Knowledge exchange on Green ICT.....	124
8.4	Conclusion.....	124
9	Magnetism in clean energy and environment	126
9.1	Introduction	126
9.2	Magnetism in clean energy generation – a case study wind energy	127
9.2.1	Structure of wind Turbine.....	127
9.2.2	Energy storage system: flywheel.....	127
9.2.3	Frictional loss and limitation of existing bearing system	128
9.2.4	Magnetic bearing	128
9.2.5	Superconductor bearings	129
9.3	Magnetism in fusion power	129
9.3.1	Current problem in nuclear fusion.....	130

9.3.2	Levitated dipole experiment (LDX)	130
9.4	Magnetism in refrigerating technology	130
9.4.1	Current problem in refrigeration.....	130
9.4.2	<i>Magnetic refrigeration</i>	130
9.4.3	Mechanism of magnetic refrigeration.....	131
9.4.4	Advantages over current vapor-compression refrigeration system	131
9.4.5	<i>Obstacles and vision</i>	133
9.5	Outlook.....	133

Section 4: Innovations and Applications

10	Open Innovation for Environmental Research.....	136
11	Case: Town Island Renewable Energy Supply System	154
11.1	Introduction	154
11.2	Town Island	154
11.3	Path towards a RE supply system.....	157
11.4	The Town Island RE supply system.....	157
11.4.1	RE option.....	157
11.5	The RE supply system	158
11.6	The project team	158
11.7	Project implementation.....	158
11.7.1	Phase One	158
11.8	Phase Two	161
11.9	The challenges	161
11.9.1	Capacity planning	161
11.9.2	Permit application.....	161
11.10	Technology selection.....	162
11.10.1	PV technology	162
11.10.2	Battery technology.....	162
11.10.3	Other technologies.....	162
11.11	Engineering design	163
11.12	Site remoteness	163
11.13	Community values.....	163
11.14	Education and research.....	163

11.15	Community care and support.....	164
11.16	Conclusion.....	164
12	Local Weather Effect on the Town Island PV system.....	166
12.1	Introduction.....	166
12.2	Research methodologies.....	167
12.2.1	Data Cleansing and Conversion.....	167
12.2.2	Data Analysis.....	168
12.3	Data mining and relationship building.....	169
12.4	Gaps between the expected results and actual results.....	169
12.5	Results.....	169
12.5.1	SOC and ambient temperature.....	169
12.5.2	SOC and wind speed.....	170
12.5.3	SOC and solar radiation (Before data filtering).....	170
12.5.4	SOC and solar radiation (After data filtering).....	171
12.5.5	Inverter output and Solar Radiation.....	172
12.5.6	Effect of direct and diffuse sunlight.....	172
12.6	Conclusions.....	174
13	Case– Hong Kong Schools Solar Education Programme.....	175
13.1	Introduction – MaWan School BIPV project.....	175
13.1.1	Background of the project.....	176
13.1.2	Monitoring system.....	178
13.1.3	Details of data.....	181
13.2	Detail settings of BIPV systems.....	182
13.2.1	Deck-shading (system 1).....	185
13.2.2	Rooflight (system 2).....	187
13.2.3	Canopy (system 3).....	188
13.3	Summary of the BIPV system performance.....	188
13.4	Conclusion.....	192
14	Acknowledgements.....	196

Table of tables

Table 3-1 A comparison of traditional power grid and smart grid.	45
Table 3-2 Requirements of SANET actors for different SG applications.	53
Table 3-3. Mechanisms to address the major challenges.	54
Table 3-4. Power conserving mechanisms	57
Table 3-5. Power harvesting mechanisms.	58
Table 5-1 Renewable energy target for major countries.	74
Table 5-2 Geometric parameters of a typical micro wind turbine.	76
Table 5-3 Increase in power with increasing the number of turbine	80
Table 5-4 Power obtained for a 8-micro-wind-turbine system at various wind speeds.....	80
Table 8-1 Figures of web-mail uses as at February 2008.....	116
Table 12-1 Correlation Factor mapping with corresponding relationship.....	169
Table 12-2 Classification of clusters	173
Table 13-1 Characteristics of the 3 BIPV systems at MaWan School.	185
Table 13-3 BIPV energy output in relation to solar radiation and electricity consumption.....	189
Table 13-4 Summary of daily final yield.....	190
Table 13-5 Summary of performance ratio of the 3 BIPV systems.....	190

Table of Figures

Figure 1-1 The micro wind turbine was installed a reconstructed school in Sichuan.	23
Figure 2-1 Prof. Felix Wu in the smart grid simulation laboratory	27
Figure 2-2 Prof. Felix Wu and his team in the smart grid simulation laboratory	28
Figure 2-3 Modern electric grid.....	30
Figure 2-4 Topics in power system analysis.....	31
Figure 2-5 Time line of operation.....	32
Figure 2-6 Simulation hardware in the smart grid simulation laboratory.....	35
Figure 2-7 Architectural view of the smart grid	37
Figure 3-1 Prof. Victor Li and prototype of Energy Management System	42
Figure 3-2 SANET actors and closed-control-loop.	43
Figure 3-3 SANET design flow.....	44
Figure 3-4 Conceptual Reference Model of SG [1].....	46
Figure 3-5 Relation of SANET and SG.....	47
Figure 3-6 Sensors in SG.....	50
Figure 3-7 Sensor examples.	50
Figure 3-8 Actuators in SG.....	51
Figure 3-9 Actuator examples.	51
Figure 3-10 Testing the controllers and Control Logic for Smart Grid by Dr. Guanghua Yang.....	52
Figure 3-11 Three-layer structure of PERSON.	55
Figure 3-12 Compressive sensing in wind power generator management.	56
Figure 3-13 Compact wireless environment sensor.....	58
Figure 3-14 EMS architecture.	59
Figure 3-15 EMS prototypes.	60
Figure 4-1 Dr. Jin Zhong in the Smart Grid Lab	62
Figure 4-2 Traditional transmission and distribution grid.....	64
Figure 4-3 Power flows from generators to transmission and distribution grid	64
Figure 4-4 Smart meters for battery management	65
Figure 4-5 EV to Grid (V2G) technology enables more EV applications in the future	68
Figure 4-6 The System Control Center of CLP Power.....	70
Figure 5-1 Prof. Dennis Leung and the Micro Wind Turbine on a roof in HKU	73
Figure 5-2 Micro wind turbine under studying.....	75
Figure 5-3 Micro wind turbine (CAD design).....	76
Figure 5-4 Characteristic of the micro wind turbine	77
Figure 5-5 Power coefficient with different number of blades with 30-degree blade subtend-angle.....	78

Figure 5-6 Starting effect (torque) with different number of blades	78
Figure 5-7 Relationship between maximal power coefficients with the solidity.....	79
Figure 5-8 Starting effects of several high-power-coefficient micro wind turbines.....	79
Figure 5-9 Wind tunnel test of micro wind turbine system.	81
Figure 6-1 Dr. Wallace Choy and the organic thin film solar cell developed by his team.....	83
Figure 6-2 Various solar cells.....	84
Figure 6-3 The operation mechanism of an organic solid cell.	88
Figure 6-4 Reference Solar Spectral Irradiance: Air Mass 1.5 [10].	89
Figure 6-5 Dr. Wallace Choy’s team measures the efficiency for light harvesting improvement	90
Figure 7-1 Classification of vehicles.	95
Figure 7-2 Classification of HEVs.	97
Figure 7-3 Generation of electricity for BEV, PHEV and REEV.	98
Figure 7-4 Energy conversions for various EVs.....	99
Figure 7-5 Comparison of energy efficiencies between BEV and ICEV.	100
Figure 7-6 Energy recovery by regenerative braking.....	101
Figure 7-7 Comparison of local harmful emissions.	102
Figure 7-8 Comparison of global harmful emissions.	102
Figure 7-9 Comparison of vehicle noises between BEV and ICEV.....	102
Figure 7-10 Our EV appeared on HKIE’s <i>Hong Kong Engineer</i> in 1984.	103
Figure 7-11 Our IRCEV was established in 1986.	104
Figure 7-12 EV developed in HKU.....	105
Figure 7-13 Authored books about EVs.	107
Figure 7-14 Authored books chapters about EVs.....	108
Figure 7-15 Comparison of in-wheel motor drives.	109
Figure 7-16 Comparison of EVT systems.	110
Figure 7-17 Load levelling and load shaving.	111
Figure 7-18 Aggregated dual-grid V2G framework.....	112
Figure 8-1 No more paper lecture notes!.....	117
Figure 8-2 More processors packed into servers rises the server power density by 10.....	120
Figure 8-3 Variable-speed CRAC can save up to 40% of fan power consumption.	121
Figure 8-4 Reduce, reuse, recycle, recover and dispose are the five strategies for waste minimization ..	123
Figure 9-1 Philip W. T. Pong, Kelvin T. H. Hui, L. F. Cheung, K. S. Lui and an electrical machine	126
Figure 9-2 Wind turbines.....	127
Figure 9-3 Flywheel system	127
Figure 9-4 Energy efficiency of electrical machines can be improved by magnetism.....	128

Figure 9-5 The performance of traditional bearings is constrained by friction	128
Figure 9-6 Behavior of a superconductor under the influence of magnetic field	129
Figure 9-7 Schematics showing the mechanism of magnetic refrigeration	132
Figure 10-1 <i>Composition of Industry-University Collaborative ITF-funded</i>	139
Figure 10-2 Drivers for industries to collaborate with university in ITF environmental projects.....	141
Figure 10-3 Key Barriers for Industries to Collaborate with Universities	142
Figure 10-4 Competitive advantage achieved after engaging in Industry-University Collaboration	143
Figure 10-5 Types of Collaboration in Industry-University Collaboration	144
Figure 10-6 Reliance on External Sources for Ideas and Innovations.....	145
Figure 11-1 Location of the Town Island	155
Figure 11-2 Drug rehabilitation centre	156
Figure 11-3 Church.....	156
Figure 11-4 Kitchen.....	156
Figure 11-5 Hostel.....	156
Figure 11-6 Diesel generator	157
Figure 11-7 Site survey.....	159
Figure 11-8 Material delivery	159
Figure 11-9 Construction.....	159
Figure 11-10 PV panel installation	159
Figure 11-11 Equipment installation	160
Figure 11-12 Testing	160
Figure 11-13 System completion.....	160
Figure 11-14 Power on	160
Figure 11-15 Batteries of the Town Island PV System	162
Figure 12-1 Wind speed data collected from the Hong Kong Observatory	167
Figure 12-2 The PV Inverter and battery inverter in of the PV System	167
Figure 12-3 Battery SOC against ambient temperature.....	170
Figure 12-4 Pot Battery SOC against Average Wind Speed of May.....	170
Figure 12-5 Battery SOC increment against the average solar radiation	171
Figure 12-6 Battery SOC increment against the average solar radiation with clustering.....	172
Figure 12-7 Relationship of the P_{ac} and mean Diffuse and Direct Solar Radiation of May.....	172
Figure 12-8 Chart of PV output P_{ac} and Global Solar Radiation of May	172
Figure 12-9 Ratio of diffuse and direct solar radiation with different weather type clusters	173
Figure 12-10 Scatter chart of the PV output P_{ac} and ratio of diffuse and direct solar radiation	173
Figure 12-11 Relationship of the PV output P_{ac} and the ratio of diffuse and direct solar radiation	174

Figure 13-1 The model of the MaWan School designed by ASD.....177
Figure 13-2 High precision voltage and current transducers (LHS).....179
Figure 13-3 Pyranometer installed on the same plane to PV modules (RHS).....179
Figure 13-4 Web display Instantaneous power output from the School PV systems180
Figure 13-5 The structure of the monitoring system at the MaWan School.....181
Figure 13-6 Aerial photo of the completed MaWan School.....183
Figure 13-7 Numbering of the three BIPV systems.184
Figure 13-8 Completed deck-shading BIPV system.186
Figure 13-9 Sub-division of system 2.....187
Figure 13-10 Three bays of Canopy system to suit the standard HK School Planning Grid.188

Preface

From the Secretary for the Environment, HKSAR

Energy and environment always have a close relation to each other. We have been relying on fossil fuels to obtain energy for our every-day needs, like electricity consumption and road transportation. In the process, various kinds of emissions and pollutants are created which impact on our environment. There is always a pressing need for us to identify and adopt more environmentally friendly ideas and technologies to generate and utilise energy.

The Government has been actively exploring and promoting the generation and use of clean energy. One of our initiatives is the promotion of renewable energy. We have provided incentives to the two local power companies a higher rate of return for their investment in renewable energy facilities and the two local power companies have already started to explore the feasibility of offshore windfarm projects. The Government is also planning to construct and operate before 2020 an integrated waste management facility, two organic waste treatment facilities and a sludge treatment facility to harness the potential of waste-to-energy.

Buildings take up approximately 90% of the electricity consumed in Hong Kong and are responsible for at least 60% of Hong Kong's greenhouse gas emissions. Enhancement of energy efficiency can bring substantial savings in electricity bills and is a win-win strategy for both the users of buildings and the environment. We have recently enacted a new legislation to stipulate minimum energy efficiency standards for buildings. We have also implemented a \$450 million funding scheme to help existing buildings enhance the energy efficiency of their electrical installations.

Fuel consumption in the transportation source is also a major emission source in Hong Kong. We are now actively promoting the wider adoption of electric vehicles in Hong Kong. Electric vehicles have no tailpipe emissions and are promising solution to our roadside air pollution problem. Our medium-term target is to have 30% of our private cars and 15% of buses and goods vehicles being hybrid and EVs or other vehicles with similar performance by 2020. The wider adoption of electric vehicles will open up new areas on the research and development of electric vehicles and create business opportunities.

This book have introduced to readers many brilliant ideas and advanced technologies on the generation and utilization of energy, including the development of smart grid, renewable energy and electric vehicles. I hope that these ideas and technologies can be put to good use for the benefit of our environment and society.



Mr. YAU Tang Wah, Edward, JP
Secretary for the Environment
Environment Bureau

Preface

Sustainable development has attracted the attention of scientists, engineers, academics, politicians and the wider community around the globe. Clean Energy and Environment is not a dream but a target that we have to strive for our sustainable future.

It is well recognized that there are two major threats to our world currently: climate change is one and diminishing energy resources is another. When generating energy, engineers are facing the challenge of developing more types of renewable energy. Evidently, engineers need to maximize the existing energy production efficiency while at the same time to minimize carbon emission. Against the backdrop of combating climate change, we, as an energy-user, need to avoid unnecessary use, to prevent the waste of resources. We need to be able to choose the most efficient means for our intended purpose. We need to find ways to reuse any residue or leftover energy. And finally, we need to review and be conscious of our energy consumption habits. We need to adopt an energy-efficient lifestyle.

Smart Grid with the ability to provide an integrated approach for both renewable energy and utilization is the embracing technology for research, development and application. This book contains a good technical approach and direction from sensor, remote sensor and actuator networks to green information & communication technology and electric vehicles. It provides a good solid knowledge with practical examples for engineers and professionals for reference and applications.

This book is published on the International Mother Earth Day, 22 Apr 2011 and is timely to demonstrate fully the awareness of the Hong Kong Engineers and Professionals in combating the climate change. It also exhibits the good work of the contributing authors. Finally, I recommend this book to all the Hong Kong Engineers and Professionals and it is my wish that the book would inspire further engineering and technology advancement in the coming future.



Ir. Dr. Chan Fuk Cheung
Senior Vice-President,
The Hong Kong Institution of Engineers

Preface

Clean Energy and Environment – a Knowledge Exchange Project

In today's highly interconnected, globalised world, societies are increasingly aware that we should be 'green', or become 'greener', in the way we live and use the world's resources. We understand that even as IT advances are developed and adopted more rapidly than ever, we must also find ways to manage and utilise our natural resources more effectively, responsibly and sustainably.

So I am pleased to see the launch of this Knowledge Exchange Project based on the theme of 'Clean Energy and Environment', which aims to exchange knowledge about clean energy and the environment with the general public, and to showcase the University's innovative research in this field. The broad research categories of Renewable Energy, Energy and Carbon Reduction, and Green Information Communication Technology, are introduced and explored in this book, and will be further developed and disseminated at a Knowledge Exchange Public Conference.

As the University celebrates its centenary, Knowledge Exchange Projects like this one remind us of the responsibilities that come with the benefits of IT advances and globalisation, and of the continuing importance of producing knowledge, of using it wisely, and sharing it widely. As such, it is outstanding example of the 'Knowledge, Heritage and Service' that HKU stands for, and my warmest congratulations to all those who have contributed to, or are taking part in, such a timely and worthy project.



Professor Lap-Chee Tsui
Vice Chancellor, The University of Hong Kong

Preface

Professor Paul K H Tam, Pro-Vice-Chancellor/ Vice-President (Research),

Hong Kong is a global hub. In our everyday lives, we are conscious that we are intimately linked to the rest of the world through trade and business, finance, imports and exports, travels, communications, and the list goes on and on. However, we sometimes forget that we too are very much part of the global energy and environment problem.

We consume energy every second in our daily lives and few of us will stop to think about how energy consumption affects our climate and our environment. Some of us may be aware of the receding glaciers in the Arctic and Antarctica, but they seem so far away from us. We may also have read from the news about the flooding, drought, snowstorms or heat waves that happen from time to time in different parts of the Mainland and in the region. Scientists have been warning the world that climate change could be the cause of the intensity and frequency of such phenomena. Closer to home, we often see smog hanging over our city or notice the poor quality of the air we breathe in. We should be aware that we are facing the same challenges in energy and environment as the rest of the world.

The impacts of ever-increasing energy consumption on our planet are well recognized and have become a subject of on-going debate among nations. There were many unresolved issues at the 2009 Copenhagen climate summit, which essentially means that there is a lot to be done through concerted efforts internationally. The development of clean, renewable energy holds out the promise for a more sustainable and healthier future.

Technological innovation is the key to drive the development of our clean energy future. Most of us are familiar with the power of solar energy and wind energy. There are many more scientific research areas in this field, and such technologies in this field are developing at unprecedented speed.

Researchers of the Faculty of Engineering at The University of Hong Kong are at the cutting edge of research in clean energy and sustainable environment. They are not only making enormous contributions to the creation of scientific knowledge in this critically important field, but they are also keen to share their knowledge with the community. This new book introduces a range of different topics from their research to the public, including sensor and actuator networks for smart grid, wind energy and biofuel, smart grid for renewable energy, organic solar cell, electric vehicle, green ICT, green building, green

Clean Energy and Environment

building material, and remote sensor network for monitoring renewable energy. Case studies are also used to illustrate the impacts of our researchers' work in Hong Kong and the Mainland.

The University believes in the power of the knowledge we create to make a difference in enhancing quality of life. Our research in clean energy and sustainable environment will impact on our daily lives in future, from energy-efficient homes, offices and buildings, to vehicles, transport system and communication networks, etc. By sharing our knowledge through this book, we hope to promote environmental awareness and enhance the understanding of the public in clean energy. This book will also provide useful resources for general education of students. Indeed, to fight against climate change, much has yet to be done at the international, national and organizational levels, but each of us has a part to play in a new future that will benefit all of us.



Prof. Paul K.H. Tam,
Pro-Vice-Chancellor (Research),
The University of Hong Kong

Preface

Engineering is an extremely creative and exciting field. We as engineers draw upon multi-disciplinary knowledge to create new technologies. Some of these technologies have changed our lives in many ways, such as the Internet, mobile phones, and transportation. Engineers have invented engines bringing us conveniences, improving our living standards, but meanwhile, they generate green house gases, which cause global warming and environmental problems. Although new technologies may create both solutions and problems, engineers work hard to continuously to improve technologies.

I am proud that our colleagues in Electrical and Electronic Engineering, Mechanical Engineering, Civil Engineering, Computer Science and Industrial Engineering have been developing many technologies to meet the increasing requirements of energy efficient products, and environmental friendly construction and manufacturing processes. For example, a demonstration project is being planned to showcase new technologies in renewable energy generation, storage and delivery through a smart grid; a grant from Innovation & Technology Fund (ITF) has been awarded for developing photocatalysts for clean indoor air. The Faculty will also participate in the HKU-led University Grants Committee (UGC) theme-based research proposal related to the theme of “Energy and Environment”.

Engineers make tremendous contributions in making our city a better place to live in. Members of HKU Engineering continue to share knowledge of some of the new and enhanced technologies such as smart grid, micro wind turbine, solar power panel, electric vehicle, green information communication technology (ICT), etc. Being a world-class university and one of the two founding faculties of HKU, members of HKU Engineering are determined to become a world-class technology innovator.

Through the publishing of this book, it is hoped that the general public would gain more knowledge and understanding of how technology enhances our daily lives. We hope that the academia, the industry, the government and the public can work together to create a better environment for our next generation.



Prof. W.C. Chew, Chair of Electromagnetics
Dean of Engineering, The University of Hong Kong

1 Overview

Wilton W.T. Fok
Faculty of Engineering, The University of Hong Kong

When engineers and scientists invented the first engine in the Industrial Revolution since the 18th century, the way of our living had been changed significantly. Engine provided power for the modernization of human beings. But at the same time, it consumed a lot of fossil fuel energy and generated green house gases. The emission of excessive greenhouse gases is considered as a major cause of global warming and climate change. Engineers developed new technologies to facilitate our life , but on the other hand, also triggered new problems to our environment. At the same time, engineers and scientists from different disciplines also work together to solve the problems by using more advanced technologies via different approaches. The first is to find new sources of clean energy which do not emit greenhouse gases. Second, more energy saving devices or carbon proof avoidance machines should be developed. Last but not the least is to develop new applications which can substitute the environmental unfriendly processes and economic activities. Researchers, engineers and alumni from the University of Hong Kong had been working on these problems for years. It is our pleasure and honour to share their knowledge and expertise with the general public through this book.

When there are more different types of renewable energy available from different sources, for example, solar energy from the roof top or wind energy from an off-shore wind farm, an intelligent system which can automatically control and balance the renewable energy supply and demand will be critical. Professor Felix Wu, the Convenor of the Initiative on

Clean Energy and Environment, and his team are the pioneers for the development of smart grid for the future power network. A simulation system had been developed in the Smart Grid Simulation Laboratory to simulate the operation of the future grid. It is a hybrid system which combined the technology of computer simulation with real physical devices. In his

chapter, the concept of future smart grid and the operation of this simulation grid will be introduced. A video introduction of this project by Professor Wu can also be viewed on Youtube via internet.

A reliable measurement and transmission of the operational parameters in different parts of the system are critical in operation of the smart power grid. In recent years, there are many emerging technologies that can provide an effective solution to this problem. Professor Victor Li, the Associate Dean (Research) of the Faculty of Engineering, and his team developed technologies on Sensor and Actuator Networks, also called SANET, for Smart Grid. SANET can monitor real-time energy flow and information flow of the grid network.

High speed computation technology can then analyse the Generation dispatch (GD) and demand-side management (DSM), and thus provide an optimal matching between the demand and supply of renewable energy. In many real and practical cases, there may be more than one type of grid networks operated by different operators. Therefore, the challenge of optimising a heterogeneity and distributed operation in consideration of factors such as Dynamics, Scalability, Flexibility, Energy-efficiency and cost-efficiency become critical.

Professor Victor and his team are now working on the technologies on the applications of Pervasive Service-Oriented Network (PERSON), Heterogeneous network platform (HNP), Service-oriented network (SON) in solving these problems. This knowledge will be shared in Chapter 3 of this book.

In Chapter 4, another challenge of renewable energy development will be discussed. Dr. Jin Zhong and her team are working on the research of power industry and smart grid. There are facing the challenges from customers demand response, demand side management and integration of heterogeneous renewable energy sources to the power grid. These challenges can be solved by new advanced Information Communication Technology applications for the future power grid control centre.

In the development of renewable energy, Prof. Dennis Leung, from the Department of Mechanical Engineering of the University of Hong Kong, and his team had developed a micro-wind turbine system for harnessing wind energy in urban environment. Traditional wind turbines required a strong wind speed of 5-10 m/s to maintain the operation. However, the minimal wind speed for the operation of such an innovative micro-wind turbine can be reduced to 2m/s, which is more feasible for applying to

urban areas like Hong Kong and many other major cities over the world. This system was installed by HKU teachers and students in a reconstructed school in Sichuan after the earthquake in 2008. There are many factors need to be considered in the design of a micro-wind turbine, such as the tip speed ratio, blade subtend-angle effect and solidity effect. Prof. Leung will share his knowledge in this area in Chapter 5.



Figure 1-1 The micro wind turbine was installed a reconstructed school in Sichuan.

On the other hand, Dr. Wallace Choy and his team from the Department of Electrical and Electronic Engineering are working on thin film technology for the next generation solar cells.

There are different types of thin film solar cells, including organics, inorganic and photochemical thin film solar cells. The differences, strengths and weaknesses of these different solar cells will be discussed in Chapter 6.

In addition to renewable energy generation, the development of new technologies for carbon emission and energy saving is another approach to solve the climate change problem. Electrical vehicles have been identified as one of the emerging stars. Researchers from Electrical Engineering had been developing new technologies for electrical vehicles since 1980's. Our researchers were the pioneers in this development and collaborated with a few car manufactories in Japan and the States. Professor K.T. Chau, the Course Director of Electrical Engineering, will introduce these technologies and discuss energy and environmental benefit, as well as the future vision, research and development of electric vehicles in Chapter 7.

Another way to reduce carbon emission and save energy is through the adoption of new Information Communication Technology (ICT). A new term called Green ICT is now getting popular among the industry. There are basically two approaches in Green ICT to achieve carbon emission, namely ICT for Green and ICT on Green. Dr. Victor Ng, our alumni and an

Honorary Lecturer from the Department of Electrical and Electronic Engineering, together with his colleagues from the Hong Kong Productivity Council, are working on the development and promotion of Green ICT. They contributed Chapter 8 and gave some advices on Green ICT through the two approaches and seven perspectives, namely dematerialization and waste reduction; process and flow control; virtualization; ICT facilities energy optimization; eco-friendly equipment procurement and environment conscious disposal. The latest knowledge of Green ICT will be exchanged between the industry and academia through this chapter.

Besides conducting applied researches, researchers from our university also carry out fundamental research to explore ground breaking new technologies to address the demand of clean energy for environmental improvement. Dr. Philip Pong, Dr. K.S. Lui and their research teammates from the Department of Electrical and Electronic Engineering studied the application of magnetism in clean energy generation. A case of wind energy was studied to illustrate the application of magnetism in energy generation. Research issues such as the structure of wind turbine, energy storage system, flywheel, magnetic bearings, and superconductor bearings will be discussed in

Chapter 9. In addition, the application of magnetism in fusion power and refrigerating technology will also be introduced. An in-depth study of the mechanism of magnetic refrigeration and the advantages over current vapour-compression refrigeration system, as well as the obstacles and visions of this emerging technology will be included for a comprehensive coverage.

In order to foster a right environment for an open innovation for cleaner energy research in Hong Kong, some supportive government policies are essential. Dr. Jacqueline and her colleagues from the Kadoorie Institution of the University of Hong Kong had studied a few cases on the open innovation for cleaner energy research in Hong Kong and compared them with those overseas. The results of their surveys listed in Chapter 10 will be helpful for policy makers to further enhance their current supports to the industry and academia.

If the technologies are just research papers or academic theories from the laboratories, the society cannot enjoy the warfare and there will be no impact by these researches. But with the close collaboration with the industry, these technologies can be applied in real application and be really beneficial to our environment.

Our alumni Engineer C.C. Ngai and Dr. K.H. Lam are the pioneers of renewable energy project implementation in Hong Kong. C.C. Ngai and his colleagues from the CLP Power Limited had designed and installed a standalone photovoltaic solar power system in the Town Island in Sai Kung. The implementation of this project had encountered a lot of challenges, such as capacity planning, permit application, technology selection, battery technology, practical engineering design and site remoteness and so on. These challenges, as well as the community and education value and support will be shared in Chapter 11.

The project also provided a real and practical opportunity for our students to research and study. The effects of local weather on the performance of the Town Island PV system were studied. The results were very useful for the design and implementation of similar PV system in the future.

Another practical application of renewable energy was implemented in a secondary school in MaWan in the New Territories by another engineering alumni Dr. K.H. Lam and his team. The school was equipped with a Building Integrated Photovoltaic (BIPV) system with an automatic monitoring system to control and optimize the operation. It was a comprehensive

system with three sub-systems in the deck-shading area, the roof light area and the canopy area. This system brings new energy for our new generations.

Solving the climate change is a complicated problem and requires cross disciplinary collaborations. In the University of Hong Kong, the Initiative on Clean Energy and Environment is a platform for researchers from different faculties and units, such as the Faculty of Engineering, Faculty of Science, Faculty of Architecture and the Kadoorie Institution, to work together for inter-disciplinary research and implementation projects related to clean energy and environment. Besides, in the University, we also collaborate with the industry, professional bodies and alumni to tackle this problem and apply our knowledge and research outputs to the society. Let's work hand-in-hand to develop a greener environment and a better world for our future.



Dr. Wilton Fok

Section 1: Energy Management

CENTENNIAL CAMPUS
UNIVERSITY OF HONG KONG
香港大學百週年校園



*Renewable energy powers
the development of the HKU
centennial campus*

(香港)有限公司
(HK) LTD

The Future Grid for Renewable Energy

Prof. Felix Wu

Convenor of the Initiative of Clean Energy and Environment of the University of Hong Kong

Abstract: The drastic reduction of carbon emission to combat global climate change cannot be realized without a significant contribution from the electricity sector. Renewable energy resources must take a bigger share in the generation mix, effective demand response must be widely implemented, and high-capacity energy storage systems must be developed. A smart grid is necessary to manage and control the increasingly complex future grid. Certain smart grid elements – renewables, storage, microgrid, consumer choice, and smart appliances – increase uncertainty in both supply and demand of electric power. Other smart grid elements – sensors, smart meters, demand response, and communications – provide more accurate information about the power system and more refined means of control. A review of the modern power grid, the promises of the future smart grid and the need for research in smart operation of smart grids are outlined in this paper.



Figure 2-1 Prof. Felix Wu in the smart grid simulation laboratory

2.1 Introduction

It is an inconvenient truth that human actions have caused the earth to become increasingly warmer [1][2]. Modern civilization relies heavily on energy extracted from burning fossil fuels, which results in the release of greenhouse gases (carbon dioxide, methane, nitrous oxide) to the atmosphere causing global climate change. To avoid catastrophic damage to the planet and the human race, aggressive carbon reduction must start now. Electricity accounts for about 40% of greenhouse gas emissions. Electricity consumption is projected to grow from 18 trillion KWh in 2006 to 32 trillion KWh

in 2030, a 77% increase [3]. This means that 4,800 GW of new electricity generation plants must be added, more than half of which will be from developing countries. China alone accounts for 28% of this increase. The drastic reduction of global carbon emission cannot be realized without a significant contribution from the electricity sector. A fundamental transformation in the way electricity is generated, delivered, and utilized must take place, and it is necessary to “decarbonize” the power sector. Power generation must go through a big shift in its mix of fuels and technologies; coal-based generation needs to be reduced before carbon capture and storage (CCS) take effect while nuclear and renewables must make bigger contributions. The accelerated development and deployment of non-hydro renewables is already taking place, especially in Europe. The installed capacity of non-hydro renewables in Europe grew from 16 GW in 2000 to 52 GW in 2006 [4]. At the end of 2008, the EU had installed a wind capacity of 66 GW, while the US had 28 GW, and China had 12 GW. The speed of recent developments in renewable resources is nothing short of breathtaking. In the four-year period 2005-2008, global gains in (grid-connected) solar energy increased six-fold to 13 GW and increased 250% in wind energy to 121GW. In 2008, 27 GW of wind (US 8.4 GW, China 6 GW) and 5.4 GW of solar were added. China achieved its goal of 10 GW of installed wind power capacity two years ahead of schedule, and in 2009, reset its goal for 2020 onward to generate 100 GW of

wind power (from 30 GW set in the 2007 plan) and 20 GW of solar (from 1.8 GW set in the 2007 plan) [5].



Figure 2-2 Prof. Felix Wu and his team in the smart grid simulation laboratory

Some advocates claim that conservation and efficiency improvement are low-hanging fruits that could deliver half of the needed carbon reduction and some schemes are even cost saving [6][7]. Demand response in the electric grid is one such measure. *Demand response* refers to the management of customer consumption of electricity in response to supply conditions. Current demand response projects

are implemented with dedicated control systems to shed loads or services such as air conditioning, water heater, or lights in response to requests by a utility during critical times according to a pre-planned load prioritization agreement. A demand response that utilizes economic incentives (e.g., real-time pricing), coupled with technology innovation (e.g., communication networks), could be employed to induce optimal response from consumers to adjust their demands to improve the efficiency of electricity utilization, hence achieving the dual goals of reducing carbon emission and optimizing asset utilization. Asset utilization is particularly important for most developed countries, including the US and the EU, which started the expansion of the power sector half a century ago and are now facing the problem of ageing assets and opposition for new construction of generators and transmission lines.

The high penetration of renewable generation and demand response impose an immense challenge to the operation of the electric grid. The grid was built when generation was concentrated in a small number of large generators and load demand was to be met anywhere, anytime. It was designed for generators whose outputs were controllable, with load demands that were passive [8]. The only uncertainty in generation is outage, because load demands, though uncertain, have a statistically predictable aggregate behavior. The existing grid is neither built nor designed for

variable renewable generation and interactive demand response. A smart grid of the future is thus needed to accommodate the changes. In this paper, Section 2 presents a brief review of the structure and operation of the existing grid. Section 3 introduces the smart grid of the future. A conclusion is drawn in Sec. 4 on research needs for future operation of smart grids.

2.2 Modern Grid

The modern electric *grid*, or power system, is a complex system divided for convenience, into several subsystems: generation, transmission, substation, distribution, and consumption (Figure 1). A typical power system consists of a few hundred generators interconnected by a transmission network serving several hundred (transmission/distribution) substations. From a substation downward, the distribution network has a simple topology and connects to a large number of consumer loads along its path in a tree-like structure with feeders (trunks), laterals (branches), and loads (leaves). After the US Northeast blackout of 1965, the industry applied computer and communication technologies to improve operations. Real-time monitoring and control over the power system were introduced. Over the years, supervisory control and data acquisition (SCADA) systems have evolved into more sophisticated energy management systems (EMS). Remote terminal units (RTU) have been installed at generator and transmission/distribution substations to collect real-time

measurements of voltage, current, and real and reactive powers, as well as breaker status. Every two seconds or so, RTU sends the data through a communication channel to the system control center, where EMS processes data received from all RTUs over the two-second window and conducts automatic generation control (AGC) and network analysis of the interconnected system. The range of analyses includes state

estimation, contingency analysis, optimal power flows, and so on. New applications, such as congestion management, were introduced after the industry restructuring in the 1990s. The EMS makes the *bulk power* (generation-transmission-substation) side of the grid fairly smart [9].

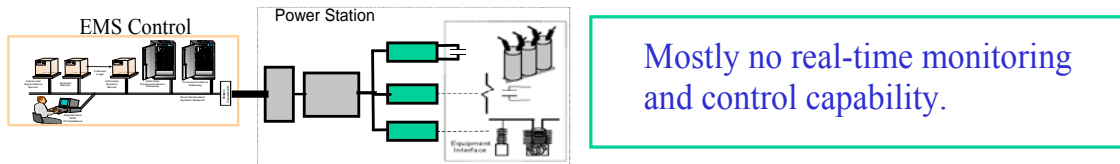
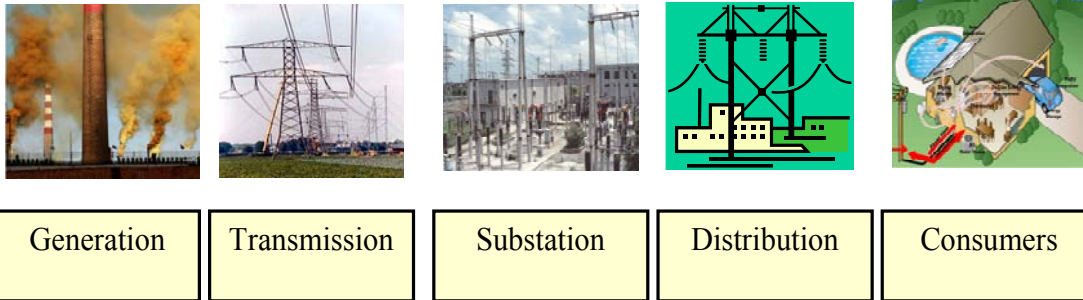

Figure 2-3 Modern electric grid.

Since the 1990s, several attempts have been made by a few forward-looking power companies to extend real-time monitoring and control capabilities to distribution systems (*distribution automation*) and to consumers (e.g., *automatic meter reading* and *direct load control*). However, the scope has not extended beyond demonstration projects. Generally, no

real-time measurements of the distribution and consumption sides of the grid are available to the system operator, and the control remains largely pre-programmed or manually operated. The visibility and reach of the system operator are therefore limited only up to substations and there is no visibility beyond the substations. The most important parts of the grid, the consumers, for whom the grid is built to serve, and the

distribution systems, where most of the service interruptions occur, are not visible to the control center in real time. This was not a serious problem in the past because of the simplicity of the distribution system and the lack of urgent need for its real-time control.

In addition to limited visibility in space, traditional EMS also has limited visibility in time. It collects RTU data in two-second intervals and has no visibility of any system change within the two-second range. Moreover,

after receiving data, EMS takes a few minutes to process and analyze them, before control functions can be taken. The change it can see and influence takes several minutes. Therefore, EMS is not expected to carry out a system-wide response to any change in less than a few minutes. Control for events that have to be countered within a few minutes, such as protective relay, transient stability, and so on [10]-[12], has to be pre-planned and pre-programmed into devices that respond with local information (Figure 2).

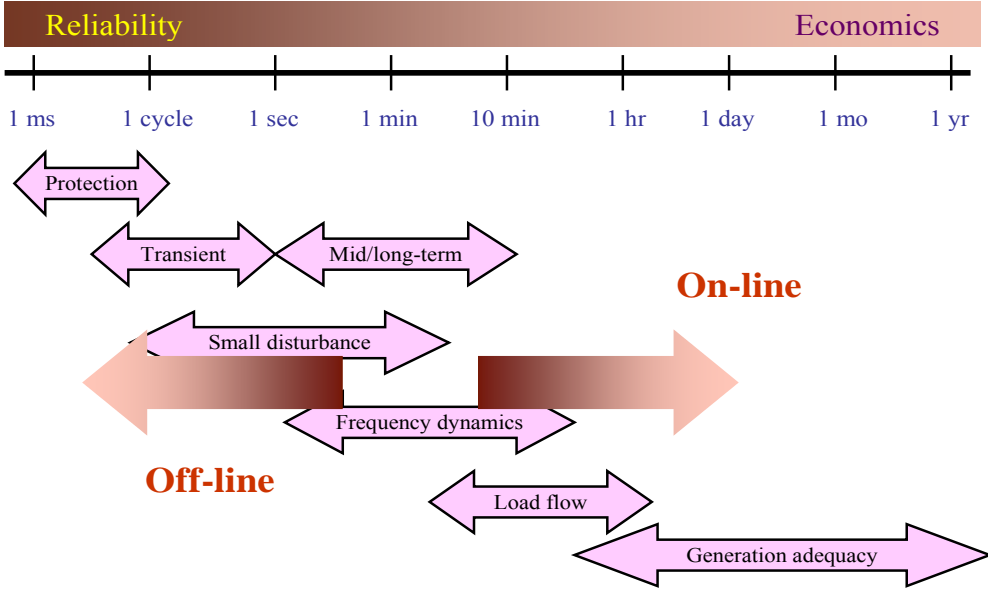

Figure 2-4 Topics in power system analysis.
(The timeline is for indication only and does not correspond to any scale.)

The limited visibility of EMS means that a defensive strategy must be adopted in power system operations. In the normal operation of a power system, consumer demand must be met by the generation and physical laws of power balance must be satisfied. Moreover, equipment, such as generators, transmission lines, and transformers, must be operated within their design limits. These limitations will be referred to collectively as *operating constraints* in system operation. To ensure that operating constraints can be met at operating time t , some time T prior to that (say $T = 1$ day), generation resources must be *scheduled* to ensure availability at time t (Figure 3). The scheduling function after industry restructuring is usually conducted through a market mechanism, starting with a day-ahead market [13],[14]. The market operator conducts an auction market and schedules generators based on bids received. Due to possible failure or forced *outage* of

generators (or transmission lines) at the actual operating time, such uncertainty, called *contingencies*, has to be taken into account at the time of scheduling. The system operator has to go through all possible contingencies to ensure that the grid can meet operating constraints in all contingent cases. This is called the *(N-1) criterion* to reflect the consideration of outage of any one of the N components in the system. When time moves closer to operating time t , more information will be available about load demand and generator status, *recourse* actions (adjustments) may become necessary on the generator schedule. Typically, the recourse is conducted in the hour ahead or balancing market. If everything is fine, one moves on to the next period. If unexpected events happen and the operating constraints are not satisfied, *emergency* control, in particular, load shedding, which is considered a last-resort heroic action, may have to be employed.

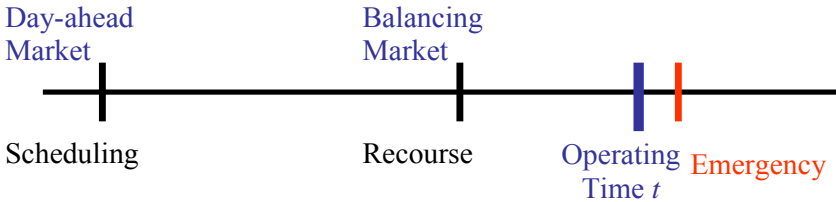

Figure 2-5 Time line of operation

The power grid has been working dutifully in the last couple of decades continuously serving

consumer demands, except for a handful of exceptionally rare cases of blackouts. It is

because the grid was built and designed for a system in which:

- (i) Load demands are passive and can be accurately forecast
- (ii) Generator outputs are controllable, that is, they can be turned up or down as needed and operated continuously to deliver power to the load, except for possible forced outages handled by the (N-1) criterion in operation

and was developed when resources were cheap and sufficient redundancy could be built in exchange for reliability.

2.3 Smart Grid of the Future

The electric grid is undergoing profound transformation due to the following:

- (i) Increasing penetration of renewable generation, such as wind and solar, whose characteristics are fundamentally different from those of conventional fossil-fuel-based generation
- (ii) Increasing participation of demand response from consumers, replacing the conventional passive load demand
- (iii) Fast development and deployment of energy storage systems, including grid-connected flywheels and batteries, which add a new dimension to the grid operation

The path toward decarbonizing the electricity sector requires a large share of electricity from renewable resources. Wind currently takes the largest share of new installed generation capacity in the EU and the US. In 2008, more than two-thirds of new generation in the US came from wind generators. Production variability of renewable energy sources, depending on meteorological conditions (wind speed on wind generation and solar radiation on solar generation), has tremendous impact on power system operation. This variability is often referred to as *intermittency*. It is well recognized that wind and solar power can vary substantially in the hour-by-hour and even minute-by-minute horizon. For example, in November 2003, wind power feeding into the territory of a German utility E.ON dropped sharply by 3640MW from a peak of 4,300 MW within only six hours, with an average value of 10 MW per minute. A more serious case happened in February 2008, when Texas experienced a drop in wind generation from more than 1,700 MW to approximately 300 MW in 10 minutes. Such rapid wind changes present a significant challenge for power system operators. Accurate forecast of wind speed is important but difficult. There are many methodologies in wind power forecasting and the research in this field is very active. The wind forecasting error currently averages at more than 10% (root mean square error) of the capacity for a day-ahead forecast, and reduces progressively to around 5-6% for an hour-ahead forecast [15].

In operating a power grid with significant renewable resources, such generation must be treated as a stochastic output whose probability distribution is better represented by continuous distribution, rather than discrete (available or unavailable) for conventional generators. The probability distribution curve is often called generation *availability curve*. If a renewable generator must be treated as an “equivalent” conventional generator to fit into current operating practices, then a large reserve capacity provided by the conventional generator is needed [16] [17]. As a result, the associated carbon reduction will not be as great as expected. The conventional wisdom is that, without changes in the way system operates, the grid operation will not be seriously affected when renewable penetration (primarily wind) is less than 20% [18]. Rapid deployment of renewable resources in some parts of the world may soon exceed that limit. California is among the more aggressive societies, and it targets 20% of retail load to be served from renewable resources by 2010 and 33% by 2020 [19].

On the consumption side, many utilities are developing *Advanced Metering Infrastructure* (AMI) projects that install smart meters on consumer premises for demand response and the communication systems to connect the meters to distribution control centers. Advanced two-way communications systems and smart meters improve the ability of electricity suppliers and consumers to communicate with one another and make optimal decisions about how and

when to produce and consume electricity. Operational efficiency can thus greatly improve, wastage of non-essential consumption can be eliminated, and existing generation and transmission assets can be fully utilized. Once a two-way communication system is in place in the power distribution system, other distribution automation (DA) functions, such as feeder reconfiguration, capacitor switching (voltage/var control), as well as dispersed resource management, which require a communication system, can piggyback on AMI and save costs.

The main challenge in power system operation has always been the requirement for instantaneous power balance, due to a lack of storage capability in the grid. Demand response helps, but it may not be enough to compensate for the highly volatile fluctuation of the output of wind generators. A storage system is considered key to opening the possibility of high penetration of wind and solar generation [20]. Storage systems will greatly enhance the controllability of the grid as well. Storage systems may be integrated with renewable energy generation in either grid-connected or stand-alone applications. They are expected to be effective in providing the following services:

- (i) *Load-leveling* service: charge at night when wind is usually strong and discharge during the day when the demand is high

- (ii) *Load-following* service: supply power to follow load fluctuation, typically in a 5 to 15-minute range
- (iii) *Frequency-control* service: adjust power output in response to power imbalance within a few seconds

In addition to pumped hydro storage and compressed air energy storage (CAES), new technologies have been developed in recent

years for flywheel energy storage, and battery energy storage systems. Technology innovation in battery storage systems, such as sodium sulfur (NaS), vanadium redox flow battery (VRB), lithium ion, and lithium polymer batteries, will likely make a great impact on the operation of the future grid. Batteries in electric vehicles (including plug-in hybrid electric vehicles, PHEV) could also be utilized effectively as storage systems of the grid.



Figure 2-6 Simulation hardware in the smart grid simulation laboratory

Both large-scale centralized and small-scale distributed (or dispersed) renewable generation and storage systems are being developed.

Dispersed resources (wind, solar, battery storage, flywheel storage, microturbines, etc.) are generation typically installed on the

consumer premise or on the distribution circuit. They could be configured as a semi-autonomous *microgrid* that can be cut off from the main grid, when so instructed, and continue to operate [21]. They could also simply be integrated in the distribution system. With the new focus on demand response, dispersed resources, electric vehicles, smart homes, smart appliances, and so on, the future distribution-consumption system will be structurally very different. The operation of that part of the grid (from substations, distribution networks, down to the consumers), unlike bulk power systems (generation-transmission-substation), has changed very little during the years of information technology revolution. The future distribution system will no longer be simply stringing together passive load demands. It will be a system with generation and interactive consumers that could provide essential resources for supply-demand balance back to the bulk power systems. This part of the grid, which has millions of points of contact versus hundreds or thousands in the bulk power system, must become *smart*.

- (i) accommodating all generation, including renewable resources, and storage options;
- (ii) enabling active participation by consumers in demand response;
- (iii) optimizing assets and operating efficiency;
- (iv) providing good power quality for electricity supply;
- (v) self-healing capability from power disturbance events;
- (vi) operating resiliency against physical and cyber attacks; and
- (vii) enabling new products, services, and markets.

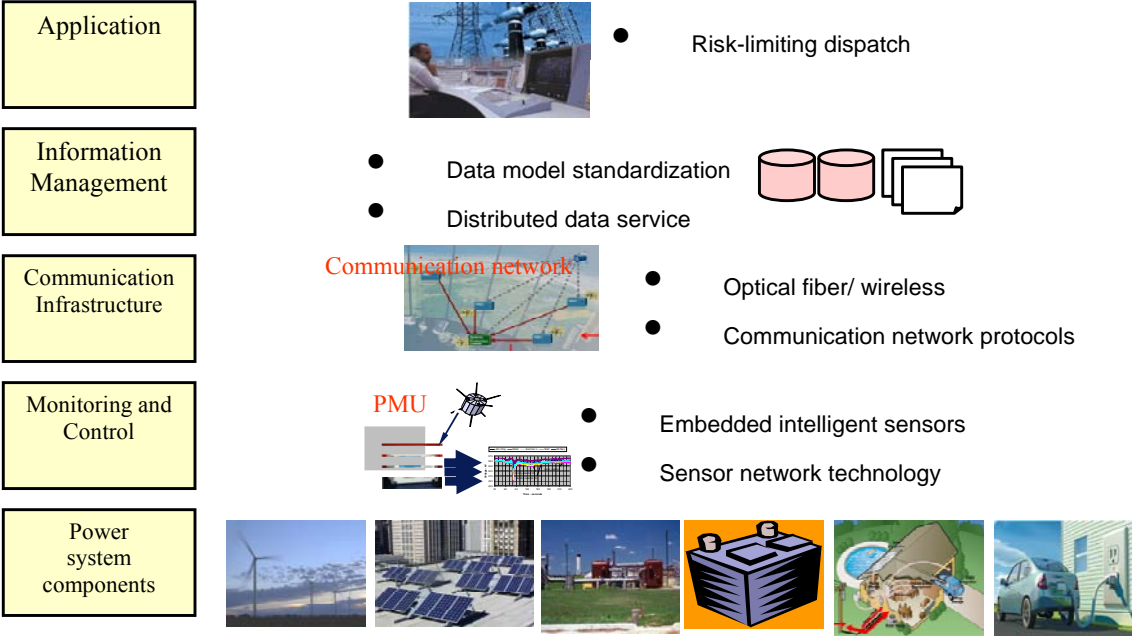

Figure 2-7 Architectural view of the smart grid

The vision of a smart grid calls for ubiquitous and seamless communications throughout the grid to enable efficient monitoring, management, and control of all power system components. That means that the traditional EMS and the newly developed AMI must be integrated in the future. Standards and protocols must be developed. From the architectural point of view (Figure 2-7), a smart grid consists of a large number of power system components, including renewables, storage, smart homes,

EVs and PHEVs, and so on. Sensors¹ are embedded in power system components and are used for monitoring and control of the grid. Sensor readings are exchanged through a ubiquitous communication infrastructure whose physical layer may be a combination of wires

¹ Recent developments in synchronized real-time measurements (PMU) to replace RTU and the Wide Area Measurement Systems (WAMS) are just the beginning of a new generation of sensors in bulk power systems [32].

(power line carrier, cable, optical fiber) and wireless, as long as standard protocols for interoperability is adhered to. The vast amount of data has to be managed to provide useful information for various applications that facilitate efficient system operation.

2.4 Conclusion

The uncertainties in the operation of a conventional power system stems from two sources: (i) major equipment (generator, transmission line, transformer, etc.) failures, called outages; and (ii) load demand variations. To response to uncertainties, sufficient controllable generation (in the form of “reserved” generation) is always on stand-by in the system. Moreover, (N-1)-criterion is used to ensure that the system can withstand, with possible re-dispatch of generation, any credible contingency. Scheduling and control functions, such as unit commitment, economic dispatch, automatic generation control, are operated under the principle that “generation follows the load”.

Concern about climate change has prompted world-wide adoption of renewable energy resources. Renewable resources are fundamentally different in its generation characteristics from the conventional fossil-fuel based generation. The most salient feature lies in the variability and uncertainty of its output. It challenges the foundation of the operation of electricity grids that is based on deterministic worst-case analysis. It has been suggested that

the uncertainty in renewable generation can be treated in the same manner as that of load demand and the same practices of power system operation can be maintained unaltered. This is certainly possible if the percentage of renewable generation is reasonably small, say a few percentage points. However, when the penetration of renewables reaches 30% or more, one is confronted with the dilemma. To build the level of required fossil-fuel “reserve” generation will not only be costly, but also environmentally counter-productive, as the stand-by generation emits carbon and renewable generation would be “spilled” for ease of operation. The alternative could be not having enough controllable generation.

Strategies to meet the challenges of large percentage of renewable resources connected to the grid fall into three categories:

- (i) on the supply side, provide more energy storage capability
- (ii) on the demand side, make demand follows the generation
- (iii) on supply-demand balance, provide tighter feedback.

All three strategies are pursued in the current effort in smart grid research. The smart grid is being introduced for the purpose of facilitating effective integration of such new elements into the power system using information and communication technologies.

A new operating paradigm, called risk-limiting dispatch, that uses real-time information about supply and demand obtained from the smart grid, taking into account the stochastic nature of renewable sources and demand response, has been proposed [33]. The operational decision making of the proposed approach is based on the criterion of limiting the *risk* in operation, rather than the conventional worst-case dispatch. Communications requirements of risk-limiting dispatch are discussed elsewhere.

Acknowledgement

This work was supported by the HKU Initiative on Clean Energy and Environment (ICEE), and the Research Grant Council of Hong Kong (HKU7179/07E).

References

- [1] A. Gore, *An Inconvenient Truth*, Rodale, 2006.
- [2] Intergovernmental Panel on Climate Change, *Fourth Assessment Report 2007*, http://www.ipcc.ch/pdf/assessment-report/ar4/syr/ar4_syr_spm.pdf
- [3] International Energy Agency, *World Energy Outlook 2009*, http://www.worldenergyoutlook.org/docs/weo2009/WEO2009_es_english.pdf
- [4] US Energy Information Administration, *World Net Geothermal, Solar, Wind and Wood and Waste Electric Power Generation, 1980-2006*, <http://www.eia.doe.gov/iea/elec.html>
- [5] “Renewables Global Status Report 2009 Update”, *Renewable Energy World Magazine*, vol. 12, issue 4, July/August 2009. <http://www.renewableenergyworld.com/renewable-energy-world>
- [6] N. Stern, *The Economics of Climate Change: The Stern Review*, Cambridge University Press, 2007.
- [7] P. Enkvist, T. Naucler, J. Rosander, “A cost curve for greenhouse gas reduction”, *The McKinsey Quarterly*, 2007. Available at https://www.mckinseyquarterly.com/ghost.aspx?ID=/A_cost_curve_for_greenhouse_gas_reduction_1911
- [8] M. D. Ilic, “From Hierarchical to Open Access Electric Power Systems”, *Proceedings of the IEEE*, vol. 95, no. 5, May 2007, pp. 1060-1084.
- [9] F. F. Wu, K. Moslehi, A. Bose, “Power System Control Centers: Past, Present and Future,” *Proceedings of the IEEE*, Vol. 93, Issue 11, Nov. 2005, pp. 1890-1908.
- [10] J. Machowski, J. Bialek, J. Bumby, *Power System Dynamics: Stability and Control*, Wiley, 2nd edition, 2008.
- [11] P. Kundur, *Power System Stability and Control*, McGraw-Hill, 1994.
- [12] L. Grigsby (ed.), *Power System Stability and Control*, CRC Press, 2nd edition, 2007.

- [13] S. Stoft, *Power System Economics: Designing Markets for Electricity*, Wiley, 2002.
- [14] D. S. K. Kirschen, *Fundamentals of Power System Economics*, John Wiley, 2004.
- [15] PJM Intermittent Resource Working Group,
<http://www.pjm.com/committees-and-groups/working-groups/irwg.aspx>
- [16] E. Kahn, "The reliability of distributed wind generation", *Electric Power Systems Research*, 2 (1979), pp. 1-14.
- [17] T. Yong, R. Enriken, P. Zhang, "Reserve Determination for System with Large Wind Generation", *IEEE Power & Energy Society General Meeting*, 2009.
- [18] U.S. Department of Energy, 20% Wind Energy by 2030, DOE/GO-102008-2567, July 2008.
<http://www.nrel.gov/docs/fy08osti/41869.pdf>
- [19] D. L. Hawkins, J. Blatchford, Y. Makarov, "Wind integration issues and solutions in California", *IEEE Power & Energy Society General Meeting*, 2007.
- [20] B. Roberts, "Capturing Grid Power", *IEEE Power & Energy Magazine*, July 2009.
- [21] R. Galvin, K. Yeager, *Perfect Power*, McGraw Hill, 2009.
- [22] European Commission, *European SmartGrids Technology Platform: Vision and Strategy for Europe's Electricity Networks of the Future*, Directorate-General for Research, Sustainable Energy Systems, EUR 22040, 2006.
- [23] U.S. Department of Energy, *Grid 2030: A National Vision for Electricity's Second 100 Years*, July 2003.
- [24] "The Emerging Smart Grid: Investment and Entrepreneurial Potential in the Electric Power Grid of the Future", Global Environment Fund and Center for Smart Energy, Oct. 2005.
- [25] Other Smart Grid websites of interests include: EPRI IntelliGrid, <http://intelligrid.epri.com/>, The Smart-Grid Revolution, http://www.america.gov/smart_grid.html?gclid=CMWQgaKZkaACFYMvpAodsiOcdw, Smart grid analysis <http://www.smartgridanalysis.com/>, Smart grid standards, US NIST, <http://www.nist.gov/smartgrid/>.
- [26] S. Massoud Amin and B. F. Wollenberg, "Toward a smart grid: power delivery for the 21st century" *IEEE Power and Energy Magazine*, Vol. 3, No. 5, 2005, pp. 34-41.
- [27] T. F. Garrity, "Getting Smart", *IEEE Power & Energy Magazine*, May 2009, pp.38-45.
- [28] S. M. Kaplan, et al. *Smart Grid*, US Government Series, The Capitol.Net, 2009.
- [29] Clark W. Geillings, *The Smart Grid: Enabling Energy Efficiency and Demand Response*, CRC Press, 2009.
- [30] R. M. Strzelecki, G. P. Benysek (ed.), *Power Electronics in Smart Energy Networks*, Springer, 2008.

- [31] US Department of Energy, The Smart Grid: An Introduction, [http://www.oe.energy.gov/DocumentsandMedia/DOE_SG_Book_Single_Pages\(1\).pdf](http://www.oe.energy.gov/DocumentsandMedia/DOE_SG_Book_Single_Pages(1).pdf)
- [32] A. G. Phadke, J. S. Thorp, *Synchronized Phasor Measurements and Their Applications*, Springer, 2009.
- [33] P. Varaiya, F. F. Wu, J. Bialek, "Smart Operation of Smart Grid: Risk-limiting Dispatch", (invited paper), *Proceedings of the IEEE*, Vol. 99, No.1, Jan 2011, pp. 40-57.
- [34] V. O. K. Li, F. F. Wu, J. Zhong, "Communcatin requirements for risk-limiting dispatch in smart grid", *IEEE International Communication Conference*, Cape Town, 2010

Watch the research video

An interview with Prof. Felix Wu about the Future Smart Grid can be viewed on Youtube:
http://www.youtube.com/watch?v=gRR2_nF8OiQ



3 Sensor and Actuator Networks for Smart Grid

Victor OK Li and Guanghua Yang

Department of Electrical & Electronic Engineering, University of Hong Kong

Abstract

As introduced in the previous chapters, compared to traditional power grid, Smart Grid (SG) enjoys various advantages. To realize these advantages, Sensor and Actuator Networks (SANET) play a key role. In this chapter, we focus on SANET for SG. We study the composition and characteristics of SANET, identify the major applications of SANET in SG, highlight the major design issues and implementation challenges, and propose some innovative mechanisms to address these challenges. The effectiveness of the proposed schemes is verified and demonstrated with a case study of Energy Management System (EMS).

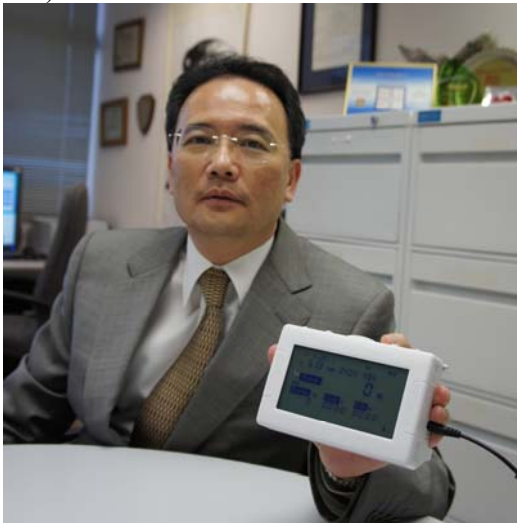

Figure 3-1 Prof. Victor Li and prototype of Energy Management System

3.1 Introduction

In the past few years, Smart Grid (SG) has attracted much interest from governments, power companies, and research institutes. Compared to the traditional power grid, by employing advanced Information Technologies (IT), SG can achieve better reliability and stability, higher penetration of renewable energy (RE), higher energy efficiency and lower greenhouse gas emission.

To realize these advantages, Sensor and Actuator Networks (SANET) play a key role. Compared to its ancestor, Sensor Networks, SANET can not only sense the environment, but also react to it. This characteristic makes SANET an essential enabling technology for

various monitoring and control applications. However, to properly design an effective SANET for SG, we must overcome many challenges.

In this chapter, we will introduce the composition and characteristics of SANET, identify the major applications of SANET in SG, highlight the major design and implementation challenges and propose some innovative mechanisms to address these challenges. We also use a case study of Energy Management System (EMS) to demonstrate the effectiveness of the proposed schemes.

The rest of this chapter is organized as follows. In Section II, SANET and SG are introduced. In Section III, the major applications of SANET in SG are identified. The design issues are discussed, and the major design challenges are highlighted. In Section IV, some innovative mechanisms are proposed to address the design challenges. In Section V, an EMS is introduced as a case study. Section VI concludes the chapter.

3.2 SANET and Smart Grid

3.2.1 SANET

A SANET is a network of nodes which sense and react to their environment. Compared to traditional sensor networks, which focus on sensing, SANET can be used for both monitoring and control purposes. With SANET,

closed loop control can be achieved to support more powerful applications.

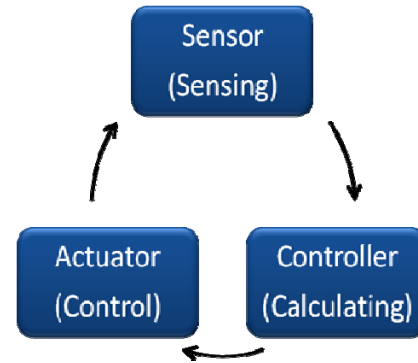

Figure 3-2 SANET actors and closed-control-loop.

Major actors in SANET include sensors, actuators, controllers and communication networks. Sensors are components or devices to measure and convert physical properties into electrical signals and/or data. Controllers perform calculations on the sensed data and make control decisions. Actuators execute the control decisions, convert electrical signals into physical phenomena (e.g. displays) or actions (e.g. switches). Different actors may be physically separated or located in a single device. Actors in a SANET communicate with each other through communication networks, operating diverse kinds of protocols and media, to enable collaboration among nodes and interaction between nodes and the surrounding environment. SANET actors and the closed loop control are shown in Figure 4-2.

3.2.2 SANET Design Considerations

SANET design is application-centric, which means the major design requirements are determined by the specific application. Given the application requirements, the following questions need to be considered and answered:

- (i) To realize the application, what are the required functions?
The requirements on physical properties, physical phenomena or actions, control logic and communication networks, need to be determined.

- (ii) To realize the function requirements, what are the required actors?
Specifically, which sensors, actuators, controllers and communication media, standards and protocols, need to be determined.

Figure 3-3 shows the simplified design flow, which leads to the determination of the actors for the SANET to achieve the specific application requirements.

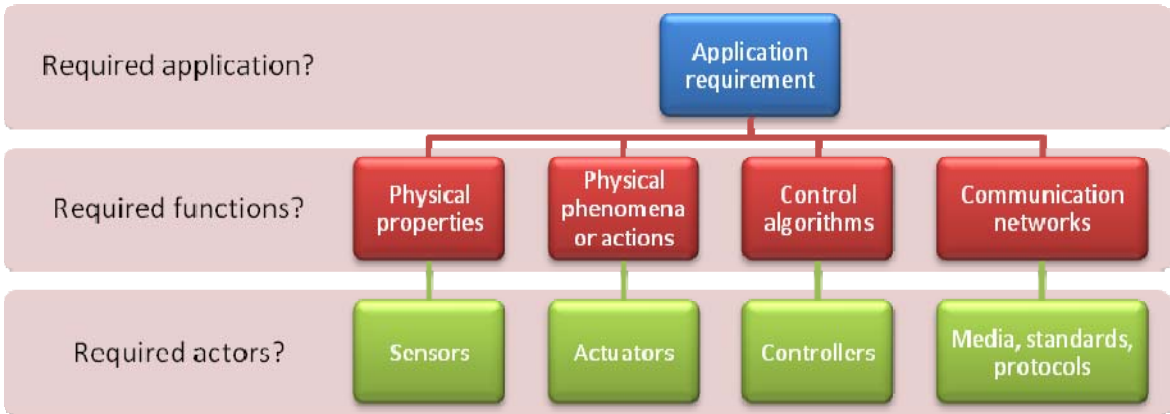

Figure 3-3 SANET design flow.

3.2.3 Smart Grid

As introduced in the previous chapters, compared to traditional power grid, SG enjoys various promising advantages. A comparison of traditional power grid and SG is shown in Table 3-1. There are three major driving forces of SG:

- (i) Reducing greenhouse gas emissions to enable sustainability;
- (ii) Improving security and reliability;
- (iii) Enhancing energy efficiency.

These objectives are achieved by utilizing RE sources and employing modern Power Electronics and advanced Information Technologies.

	Traditional Grid	Smart Grid
System reliability	Low Reactive control, slow response and recovery	High Proactive control, fast and effective response and fast auto-restoration
Power source	Centralized Fossil fuel	Centralized + Distributed Fossil fuel + RE
Energy flow	One way From grid to customer	Two way Grid <-> Customer
Information flow	None or quite limited	Pervasive, two-way, broadband
Greenhouse gas emissions	High	Low Via increasing penetration of RE
Energy efficiency	Low	High Via better balance of supply and demand
Cyber security	No	Resilient against cyber attack
Customer participation	No participation	Better customer awareness and active participation

Table 3-1 A comparison of traditional power grid and smart grid.

3.2.4 Energy flow and information flow

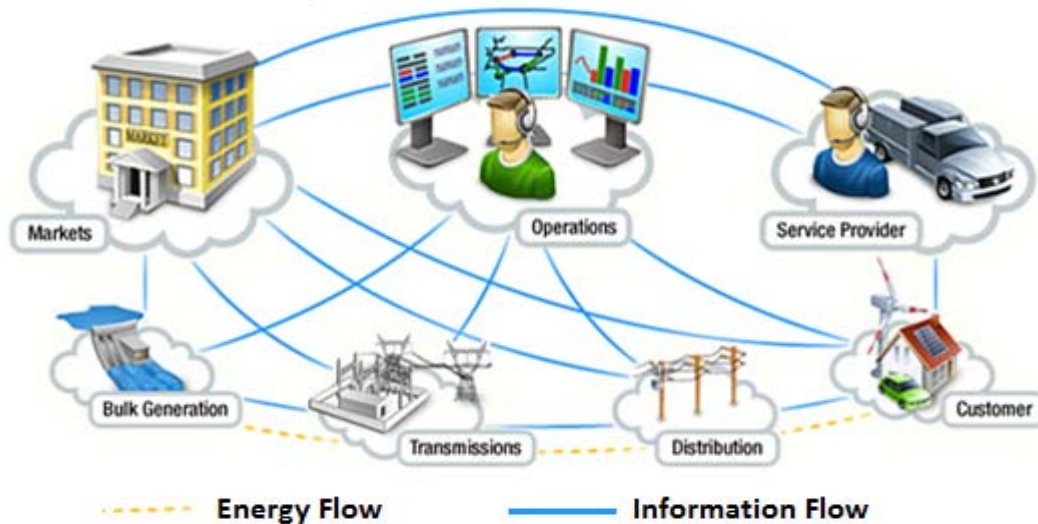

Figure 3-4 Conceptual Reference Model of SG [1].

As shown in Figure 3-4, the Conceptual Reference Model of SG proposed by NIST [1] divides an SG into seven domains, specifically, Customer, Markets, Service Provider, Operations, Bulk Generation, Transmissions, and Distribution. Connections among the different domains support two kinds of flows: Energy Flow and Information Flow.

1) Energy flow

The major energy flow is sourced at the Bulk Generation domain, delivered through the Transmissions and Distribution domain, and consumed at the Customer domain. This flow is similar to what has existed in traditional power grid for decades. Besides the major energy flow,

in an SG, there is energy flow in the reverse direction, from the distributed generators in the Customer domain to the distribution networks.

The energy flow can be measured by energy measurement devices, such as power meters and power gauges. Meanwhile, the energy flow can be manipulated by actuators, such as breakers and switches.

Although the power grid is a homogeneous network in terms of the way energy is distributed, monitored and controlled, the energy flow is quite dynamic in terms of quantity and quality. The dynamicity is due to variations in supplies and demands, dynamic

user behaviours, and continuously changing environments. In an SG, increasing usage of RE sources, such as wind turbine and solar panels, makes the problem even more challenging.

2) Information flow

In the traditional power grid, there is limited information flow. The most significant improvement of SG compared to traditional power grid is the deployment of a full-fledged SANET infrastructure, which carries all the information generated and consumed in an SG, such as real-time measurements, historical data, external events, control decisions, etc.

The information is exchanged among distributed actors within or among domains through diverse kinds of communication channels. The communication channels form a communication network, which is generally a heterogeneous and distributed network. The distributed nature is due to actors being physically distributed throughout the space. While heterogeneity is inevitable because different actors may follow different communication protocols, use different media (wire or wireless) and have different communication capabilities.

3.3 SANET in Smart Grid

From the energy flow and the information flow point of view, SG applications can be viewed as energy flow management and optimization by utilizing the information flow. This processing requires the capability of physical parameter

sensing, decision making and physical device control.

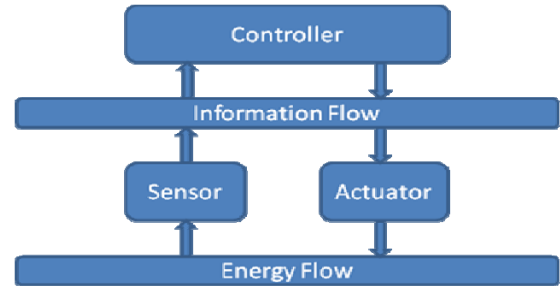

Figure 3-5 Relation of SANET and SG.

A high-level description of SANET in SG is shown in Figure 3-5. By employing SANET in SG, the energy flow and its supporting infrastructures are sensed by distributed sensors. Through information flow, the sensed data is transmitted to controllers for decision making. Controllers make control decisions and issue control commands to the actuators, also through the information flow. On receiving the control commands, actuators execute the control tasks.

3.4 Applications of SANET in SG

As introduced in the previous section, the three major driving forces of SG include reducing greenhouse gas emissions, improving security and reliability, and enhancing energy efficiency. Below, we will elaborate on three major SG applications to show why it is necessary to deploy SANET in SG and how SANET help achieve the three major objectives.

3.4.1 RE Penetration

RE is expected to help to reduce the emissions of greenhouse gases and other pollutants. RE sources include non-variable ones and variable ones. Non-variable RE sources, such as hydro, have already been widely utilized in existing power grids for decades. However, due to their intermittent nature, penetrations of variable RE sources, such as wind and solar, in considerable amount (more than 10%) may cause severe problems in maintaining the stability of the power grid.

With the help of SANET, accurate and up-to-date environmental information, such as wind speed, solar intensity, can be obtained to predict the characteristics of the RE generators. Furthermore, based on the measurements and predictions, compensation mechanisms can be employed to adaptively control the backup generators, advanced storages or even customer power loads to address the fluctuations of the RE supplies.

More information of sensor network for RE can be found in another chapter of this book.

3.4.2 Grid monitoring and control (GMC)

Reliability is critical in the electricity network ever since its birth. However, the big blackout in U.S. in 2003 indicated that the traditional electricity grid is still unreliable. A recent report

showed that the U.S. power grid is getting less and less reliable over the years [2].

GMC is essential for reliable, secure, and high-quality electricity services. SANET plays a key role in GMC, as it can continuously monitor and efficiently control the whole system.

The core duties of SANET in GMC include preventive and corrective functions. Specifically, SANET is required to monitor equipment health, predict and detect disturbances, prevent potential failures, respond quickly to energy generation and consumption fluctuations and catastrophic events, and enable fast auto-restoration or self-healing.

Diverse kinds of SANET have been invented and employed for GMC, such as Supervisory Control and Data Acquisition (SCADA), which has been used in power grid for decades, and, most recently, Phasor Measurement Units (PMU) and Wide-Area Measurement System (WAMS), which provide real-time monitoring on power quality and in some cases respond to them automatically on a regional and even national scale.

3.4.3 Generation dispatch (GD) and demand-side management (DSM)

An effective power grid requires a good balance between the power supply and the power demand. GD and DSM are effective mechanisms to maintain the required balance and thus improve the energy efficiency.

GD is a monitor and control mechanism to actively manage electricity generation such that the amount of power generated meets the demands at any time. GD is already deployed and plays an important role in traditional power grid. However, this function in SG must overcome additional challenges, as it has to actively manage significant amount of distributed energy resources, especially RE resources at the Customer domain.

With the help of SANET, Renewable Forecasting (RF) and real-time Grid Frequency Regulation (GFR) are two effective mechanisms to address the RE penetration problem in GD. RF [3] requires real-time Distributed Energy Resources (DER) information to be sensed and gathered at the control centers; and after fast analysis, proper commands issued to generation scheduling and regulation functions. Real-time GFR [4] helps to optimize generation scheduling based on the fast detection on variations of frequency and voltage level, and requires very sensitive and responsive hardware and high speed data transmission.

As the counterpart of GD located in the Generation domain, DSM, which is also known as Demand Response (DR), works primarily in the Customer domain and interacts with the Service Provider, Market, and Operation

domains. DSM manages demand side power load in response to power supply constraints. By employing automatic load management, DSM can realize peak shaving through reducing power load on peak times, or shifting power load from peak times to non-peak times.

DSM is an important application of SANET and imposes some special functional requirements on the underlying SANET, such as capabilities of real-time load monitoring, two-way data exchanging between the demand side and utilities, data processing, and demand side load control.

3.5 Actors of SANET in SG

As introduced in the previous sections, SANET is composed of sensors, actuators, controllers and communication networks. Below we highlight the major sensors and actuators commonly used in SG, and highlight the major requirements on controller and communication networks by the different SG applications.

3.5.1 Sensors in SG

Figure 3-6 lists the sensors commonly used in SG. The sensors are classified into three categories based on the type of the physical parameter measurement. Figure 3-7 shows a few sensor examples.

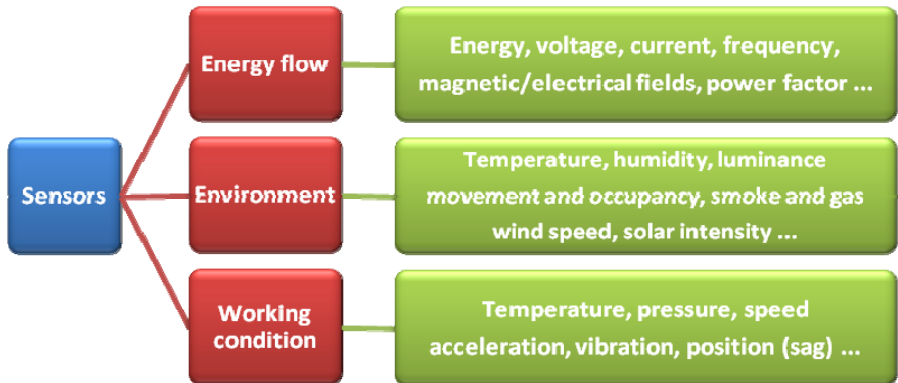

Figure 3-6 Sensors in SG.



Figure 3-7 Sensor examples.

3.5.2 Actuators in SG

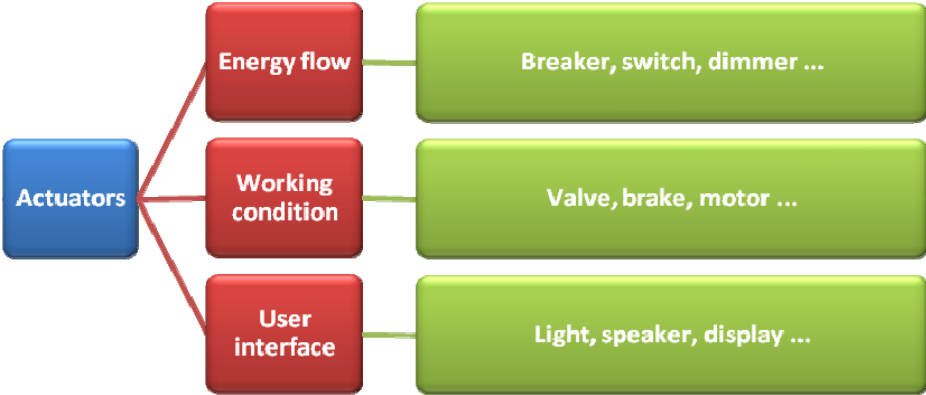

Figure 3-8 Actuators in SG.

Figure 3-8 lists the major actuators commonly used in SG. The actuators are also classified into three categories based on the type of the physical phenomena or actions. Figure 3-9 shows a few actuator examples.



Figure 3-9 Actuator examples.

3.5.3 Controllers and Control Logic in SG

Depending on the application requirements, controllers may be complicated, powerful, centralized control centers, or simple, less powerful, distributed micro-controllers. Normally, these two kinds of controllers work collaboratively to provide the monitor and control function in a single SANET application.



Figure 3-10 Testing the controllers and Control Logic for Smart Grid by Dr. Guanghai Yang

Due to the great fluctuations in energy generation and consumption, SANET applications in SG may require computationally intense control logics, such as fuzzy control and Artificial Intelligence (AI) control, to handle the dynamics, thus requiring more powerful controllers.

In addition, SANET applications in SG may require a large number of controllers to work collaboratively. DSM is such a case, where thousands of user load management units are involved. This requires each controller to be low cost to enable a large-scale deployment.

3.5.4 Communication Network

To support the advanced features of SG, the data volume exchanged among different actors in SANET inevitably increases tremendously compared to traditional power grids. Meanwhile, different SANET applications in SG normally have different communication requirements, in terms of bandwidth, transmission delay, and etc. In Table 3-2, we summarize the characteristics and requirements on different SANET actors for the three major SG applications.

SANET Apps. SANET Actors	Penetration of RE	GMC	GD & DSM
Sensors	Energy flow Environment	Energy flow Environment Working condition	Energy flow Working condition
Actuators	Energy flow	Energy flow Working condition	Energy flow Working condition User Interface
Controllers	Distributed and centralized Dynamic level: high Cost: medium to high	Distributed and centralized Dynamic level: high Cost: medium to high	Distributed and centralized Dynamic level: high Cost: Low to medium
Communication networks	Bandwidth: medium Delay: medium	Bandwidth: high Delay: stringent	Bandwidth: low Delay: medium

Table 3-2 Requirements of SANET actors for different SG applications.

3.6 Challenges of SANET in SG

Next we study the major design challenges of SANET in SG.

3.6.1 Heterogeneity and distributed operation

As pointed out in Sec. II, heterogeneity and distributed operation and two major characteristics of the information flow in SG. Since SANET relies on the information flow, the heterogeneity and distributed operation, which render the formation of a connected and

efficient information flow, become the two major challenges of SANET in SG.

3.6.2 Dynamics

The dynamicity is due to the variation of supplies and demands, dynamic user behaviors, continuously changing environments and other random events. In an SG, increasing usage of RE sources, such as wind and solar, makes the problem even more challenging.

3.6.3 Scalability

A typical SANET application in SG may cover hundreds of kilometers, and involves monitoring and control of thousands of pieces of equipment and devices. Scalability is a major challenge. It is necessary to employ protocols with low overhead and algorithms with linear complexity.

3.6.4 Flexibility

Smart grid is still evolving [5]. New technologies, policies, and user demands keep

emerging, and SANET is required to provide the flexibility to accommodate all the diversities and evolving factors.

3.6.5 Energy-efficiency and cost-efficiency

One of the driving forces of SG is to improve the efficiency of the power grid, and SANET itself must be energy-efficient. In addition, to lower the deployment barrier, it must be cost effective.

Mechanisms Challenges	Pervasive Service- Oriented Network	Context-aware Intelligent Control	Compressive Sensing	Device Technology
Heterogeneity and distributed operation	X			
Dynamics		X		
Scalability			X	X
Flexibility	X	X		X
Energy-efficiency and cost-efficiency			X	X

Table 3-3. Mechanisms to address the major challenges.

3.7 Proposed Mechanisms

In Section 3.3, we identify the major challenges of SANET in SG. In this section, we propose some effective mechanisms to address these challenges. The proposed mechanisms and corresponding challenges addressed are shown in Table 3-3

3.7.1 Pervasive Service-Oriented Network (PERSON)

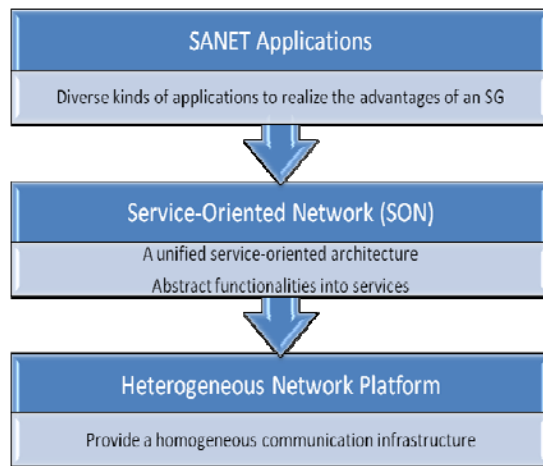

Figure 3-11 Three-layer structure of PERSON.

PERSON is a general framework to seamlessly integrate diverse kinds of actors and networks

into a unified Pervasive Service-Oriented Network to address the challenges of heterogeneity and distributed operation, and bring lots of flexibility to develop diverse kinds of SANET applications.

PERSON has a three-layer structure as shown in Figure 3-11. The principle is to decompose the complexities into different layers and to have loose coupling among different layers. In the following we will introduce the three layers one by one.

3.7.2 Heterogeneous network platform (HNP)

The objective of HNP is to build a homogeneous communication infrastructure for the information flow. HNP provides simple APIs to the upper layer for information exchanging. The upper layer does not need to care about how the information is delivered. The underlying communication protocols, media and communication capabilities are transparent to the upper layer. An implementation of such HNP can be found in [6].

3.7.3 Service-oriented network (SON)

The basic idea of SON is to achieve interoperability, modularity and reusability by abstracting the functions provided by the actors into services. To support SON, mechanisms for service creation, registration, discovery, binding and invoking are required. SON also needs to define a suite of services that can be used for SANET applications.

3.7.4 SANET applications

On this layer, the services provided by SON are exploited for specific SANET applications. The interoperability and service reusability provided by SON bring much flexibility to develop diverse kinds of applications, such as the applications introduced in the previous sections.

3.8 Context-Aware Intelligent Control

Context-aware intelligent control is proposed to address the challenges of dynamics. The basic idea is to develop proactive and context-aware control logics to optimize the system performance under dynamic environment. Here the contexts have a very broad meaning, including but not limited to

- (i) Environment parameters, such as temperature and humidity;
- (ii) Energy flow readings, such as power supply and demand level;
- (iii) Human behaviors, such as movement, preference on environment;
- (iv) Economic incentives, such as tiered electricity rates;
- (v) Regulation schemes, such as DSM, and RE penetration.

A simple example of context-awareness is occupancy-based light control, where the context is whether the room is occupied or not, and light is turned on or off based on it.

The context-aware intelligent algorithms exploit the contexts, obtained by exploiting the services of PERSON, to optimize the overall performance of a SANET application. More details of PERSON and context-aware intelligent control can be found in [7].

3.9 Compressive sensing (CS)

CS is proposed to address the challenges of scalability, energy efficiency and cost efficiency. The basic idea of CS is to exploit data correlation in the time and space domains to reduce the hardware cost and the communication cost.

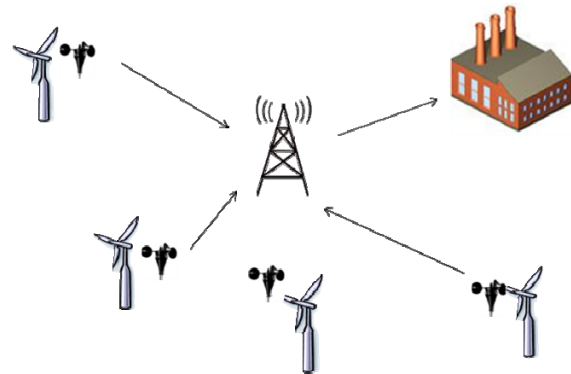

Figure 3-12 Compressive sensing in wind power generator management.

Consider a distributed wind power generator management system as shown in Figure 4-12 in which a number of micro wind power generators are located closely in the Customer domain. The

amount of power generated by each wind turbine highly depends on the experienced wind speed. In order to get the accurate information of DER for a better GD, the wind speed need to be measured in real-time and the measurement results should be transmitted to the control center. One option is to install wind speed meters at all the wind turbines, which is costly not only on hardware but also on data transmission. Since wind conditions in adjacent areas are similar, we can exploit such correlation in spatial domain and deploy fewer sensors with less cost on hardware and data communication.

The methodologies employed in CS include:

- (i) Complete continuous sampling to ensure reliability and complete understanding of the correlations;

- (ii) Selective transmissions to ensure short delay and cost-effectiveness;
- (iii) Complete reconstruction based on sparse data

More details of CS can be found in [8].

3.10 Device Technologies

Advanced device technologies can help improve energy-efficiency and cost-efficiency, and make a SANET more scalable and flexible to be employed for SG applications.

3.10.1 Low power consumption design and power-harvesting technologies

The SANET itself inevitably consumes power. To reduce the total power consumption, low power consumption design is required. In addition, mechanisms for power-harvesting are preferred.

Actor	Power conserving mechanisms
Sensing	Compressive sensing to exploit correlations in time and space domains Sensing on demand to avoid continuous and unnecessary sensing
Control	Event-based control
Calculating	Low complexity algorithm
Data transmission	Compressive sensing Distributed data processing and control instead of centralized control Data compression and data aggregation Low power data transmission technologies

Table 3-4 Power conserving mechanisms

In a SANET, all the major functions, such as sensing, control, calculating and data transmission, consume power. In Table 3-4, we list the potential mechanisms to reduce power consumption. The employment of a mechanism on one actor may have impact on others. For example, data compression and data aggregation may reduce the power consumption for data transmission, but increase the power consumption for regenerating the data. So power optimization needs to be considered from a system point of view.

Power harvesting is a process by which energy is derived from external sources, captured and stored. The major power harvesting mechanisms applicable to SANET in SG are listed in Table 3-5.

Energy type	Power harvesting device (energy source)
Ambient-radiation	Solar panel (solar energy) Antenna and transducer (RF energy)
Kinetic	Piezoelectric devices (mechanical strain, motion, vibration, noise) Micro-wind turbine (wind power)
Thermal	Thermoelectric generator (thermal gradient)

Table 3-5. Power harvesting mechanisms.

3.10.2 Modular and Compact design

Modular design can enhance the reusability of the modules to reduce the hardware design cost and development cost. Compact design can lower the development cost of the SANET actors, and improve the flexibility of employing the actors in diverse kinds of SANET applications. Figure 3-13 shows a compact wireless environment sensor applicable to many SANET applications.

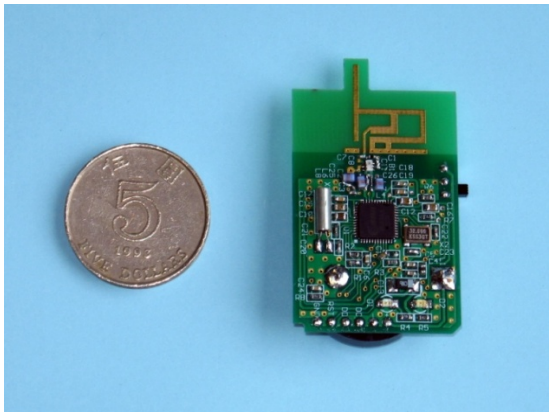

Figure 3-13 Compact wireless environment sensor.

3.11 Energy Management System at Customer Domain

Case Study of SANET in SG

In this section, we introduce an Energy Management System at the Customer domain as a case study to demonstrate the effectiveness of

the proposed PERSON framework and other mechanisms.

An EMS monitors, controls and optimizes the performance of energy generation, transmission,

distribution, and consumption. EMS is an important building block of an SG, and plays a key role in achieving the advantages of an SG.

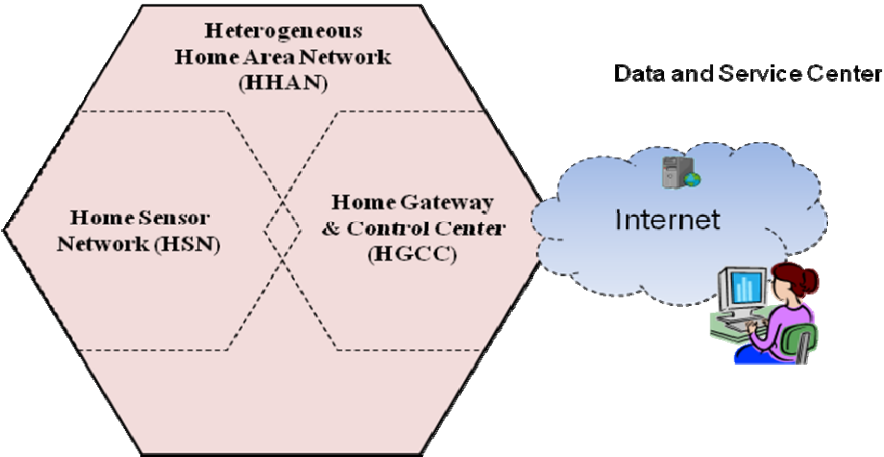

Figure 3-14 EMS architecture.

The structure of the developed EMS is shown in Figure 3-14. The EMS is composed of a Heterogeneous Home Area Network (HHAN) located in the Customer domain, and a Data and Service Center (DSC) located in the Service Provider domain





Figure 3-15 EMS prototypes.

As an implementation of PERSON framework and demonstration of the advanced device technologies, a ZigBee-based Home Sensor Network (HSN) and a ZigBee-Internet Home Gateway and Control Center (HGCC) are developed to form the HHAN. Figure 3-15 shows the relevant device prototypes. The Context-Aware Intelligent Control algorithm and the CS mechanism are implemented on the HGCC. The effectiveness of the whole system has been demonstrated in a DSM application. More details can be found in [7].

3.12 Conclusion

In this chapter, we study the SANET in SG. Through analysis and discussions, we show why SANET is important to SG and how SANET contributes to SG. We highlight the design challenges and propose some innovative mechanisms to address these challenges. These proposed ideas are representatives of our

contributions in promoting the research and development of SG.

References

1. National Institute of Standards and Technology (NIST), NIST Framework and Roadmap for Smart Grid Interoperability Standards, Release 1.0, Office of the National Coordinator for Smart Grid Interoperability, USA, Jan. 2010.
2. S.M. Amin, U.S. Electrical Grid Get Less Reliable, *IEEE Spectrum*, Jan. 2011, available at <http://spectrum.ieee.org/energy/policy/us-electrical-grid-gets-less-reliable>
3. T. Ackermann, G. Ancell, L. D. Borup, P. B. Eriksen, B. Ernst, F. Groome, M. Lange, C. Mohrlen, A. G. Orths, J. OSullivan, and M. de la Torre, Where the Wind Blows, *IEEE Power and Energy Magazine*, vol. 7, Issue 6, pp. 65 – 75
4. K.M. Rogers, R. Klump, H. Khurana, A.A. Aquino-Lugo, and T.J. Overbye, An Authenticated Control Framework for Distributed Voltage Support on the Smart Grid, *IEEE Transactions on Smart Grid*, vol. 1, NO. 1, June 2010, pp. 40–47
5. C.H. Hauser, D.E. Bakken, and A. Bose, A Failure to Communicate: Next-Generation Communication Requirements, Technologies, and Architecture for the Electric Power Grid, *IEEE Power and Energy Magazine*, Vol. 3, Issue 2, March/April 2005, pp. 47 – 55
6. V. O.K. Li, C. Li, Q. Liu, G.-H. Yang, Z.

- Zhao, K.-C. Leung, A Heterogeneous Peer-to-Peer Network Testbed, *1st International Conference on Ubiquitous and Future Networks (ICUFN 2009)*, Hong Kong, June 7-9, 2009.
7. G.-H. Yang, V. O.K. Li, Energy Management System and Pervasive Service-Oriented Networks, *1st IEEE International Conference on Smart Grid Communications (SmartGridComm 2010)*, Gaithersburg, Maryland, US, Oct. 4-6, 2010.
 8. X. Yu, H. Zhao, L. Zhang, S. Wu, B. Krishnamachari, V. O.K. Li, Cooperative Sensing and Compression in Vehicular Sensor Networks for Urban Monitoring, *2010' IEEE International Conference on Communications (ICC 2010)*, South Africa, May 23-29, 2010.

4 Smart Grid for Renewable Energy

Jin Zhong

Department of Electrical & Electronic Engineering, University of Hong Kong



Figure 4-1 Dr. Jin Zhong in the Smart Grid Lab

4.1 Introduction

With the development of electricity generation and transmission technologies in the past century, electrical energy has become the most important secondary energy utilized in the modern society. Nowadays, electricity is a necessity of daily life. In the early development

of power industry, the electricity generation is dominated by large-scale centralized power plants due to economies of scale. These power plants are usually fossil-fuel based thermal power plants. By 2009, around 66% of the electricity over the world is generated by fossil fuel based energy sources. Traditional fossil-fuel power plants are major emitters of pollutants and green house gases. According to the statistic data, one-third of the carbon emission is contributed by power plants, and coal-fired generators are responsible for three quarters of the sulfur oxide emissions. The environmental and fossil fuel depletion issues are the incentives to develop renewable energy generation technologies and integrate renewable energy to power grid.

Although the high cost of renewable energy generation is a bottleneck of renewable energy entering the electricity market, the recent renewable energy certificate (REC) and renewable portfolio standard (RPS) applied in the USA provide an obligate mechanism to power companies to supply certain percentage of the electricity from renewable energy sources. The mechanism of REC is to trade the renewable green power in separated markets:

regular electricity market and green attributes / REC market, which are independent markets. The RPS is usually mandated by the government with a percentage requirement of electricity supply from renewable energy. Renewable energy targets vary in different countries. Both EU and Australia target to have 20% of energy from renewable energy by 2020. China targets 15% by 2015. Thirty-two states of the USA have setup their own renewable energy targets from 2% to 25% instead a national target [1].

The other bottleneck of utilizing green electricity in a wide range is the grid-integration issue of renewable energy generation to power grid. Due to the un-forecastable and uncontrollable characteristics of intermittent renewable energy sources, the penetration level of renewable energy generation in a power grid is limited by the security and reliability requirement of system operation unless new technologies are developed to accommodate intermittent renewable energy generation. Smart grid provides the platform for renewable energy integration to power grid. Besides the requirement of renewable energy integration, the other need of smart grid is to improve power grid reliability and aging infrastructure, hence improve the quality of power supply and customer services.

Renewable energy generation can improve total energy efficiency whereas mitigate the environmental problem. The other method to improve energy efficiency is two-way demand side management (DSM). For example,

distributed generation, smart home and electrical vehicle (EV) are well accepted as an environmentally friendly way of demand response. The intermittent renewable energy increases generation uncertainties in power grid. Energy storage is necessary to a grid with a high penetration of renewable energy generations. The real time control on distributed generation, storage charging / discharging and demand response requires fast, two-way modern information and communication technologies. The international trend in smart grid development is to start from distribution network and demand side by installing advanced metering infrastructure (AMI), smart home, distributed renewable generation, and distributed storages. Smart grid technologies include the latest information and communication technologies (ICTs), power electronics, control and energy storage technologies, etc. In this chapter, we will discuss these issues and the application of smart grid technologies in power systems.

4.2 Power Industry and Smart Grid

Electricity generation and power industry were started from late 1880s. Power system automation technologies have been developed and applied in power grid operation and control since 1960s. The existing power system automation techniques support automatic generation control, automatic fault clearance, automatic voltage regulation, large system inter-

Clean Energy and Environment

connection, etc. The reliability of power supply has been improved significantly due to the application of automation and control techniques in the past decades.

Nowadays, power industry is facing new challenges from various aspects. With the development of economy, there is an increasing demand for electricity. However, we are facing energy issues caused by energy depletion and environmental problems. The modern society has higher requirements on reliability, security and quality of power supply. However, many transmission and distribution facilities currently on operation were built decades ago. Infrastructures for power generation and delivery need to be upgraded.



Figure 4-2 Traditional transmission and distribution grid

In traditional power systems, power flows from generators to transmission and distribution (T&D) grid then to consumers. With the installation of distributed generations at customer sides, power could also flow from customer side to power grid. Generators, grid companies and customers all have information exchange with the control center through communication networks.



Figure 4-3 Power flows from generators to transmission and distribution grid

Smart grid technologies apply to all sections of the power system, generation, transmission and distribution, and consumer, as well as control center. Customers' role in smart grid is mainly demand response. Smart meters and advanced metering infrastructure provide hardware support of demand response. The role of generation section in smart grid is renewable energy integration. For transmission and distribution systems, smart substations and the

installation of phasor measurement units (PMU) and wide area management system (WAMS) provide the possibility of forecasting fault events in advance. As the brain of the power system, control center plays an important role in smart grid. A smart control center requires integrated ICT, advanced control and improved interfaces for decision making supports. On the other hand, a mature electricity market as well as regulations and policies are needed to facilitate the functions of smart grids.

4.3 Customers Demand Response in Smart Grid

In the U.S. and some European countries, the implementations of smart grid start from customer sides. Electricity consumers, in the past, are passive users. By installing smart meters and AMI, a customer could adjust his energy consumption pattern according to real-time electricity prices. If the customer has his own distributed renewable energy generation, e.g. solar panels and small wind turbines, he can even sell surplus electricity to the grid during the peaking-load hours. In this case, smart meters will be the smart agent with optimization functions as well as two way communication functions. The AMI system installed over a distribution system will enable consumers to participate in demand response programs. With a well designed economic incentive mechanism, electricity users' energy consumption patterns could be adjusted to an optimum way. For example, some appliances are scheduled to run during the hours of low electricity prices, which

are usually non-peaking periods. The surplus electricity generated by customer-owned distributed generators is stored in batteries for selling to the grid during the peaking load hours at higher electricity prices. Customer demand response can help shaving peak load, hence reduce the capacity reserve requirement due to increasing demand. The implementation of demand response requires 1) AMI and smart meters to measure electricity consumption and response to the electricity prices and commands sent by the system operators; 2) real-time (RT) or time of use (TOU) pricing mechanisms to encourage consumers to participate in the program.



Figure 4-4 Smart meters for battery management

The AMI in smart grid is different from the automatic metering reading (AMR) that has been applied in some utilities. AMI has two-way communication and control functions. For an

AMI system, all smart meters at a smart home (electricity, gas, heat and water meters) communicate with the data concentrator through local area network (LAN). Through the wide area network (WAN), the concentrator exchange data with AMI host server, which is managed by the meter data management system (MDMS). Installing smart meter is the first step of implementing smart grid. In some countries, electricity utilities have started to install smart

meters for their customers. In Italy, smart meters have been installed in over 30 million homes, which lead to 5% energy saving per year. In the U.S., 13 million smart meters have been installed by 2010, more will be installed in the near future. Tokyo Electric Power plans to install smart meters to their 27 million customers free of charge. Some other countries are also planning to start smart meter and AMI projects.



4.4 Renewable Energy Integration to Power Grid

Renewable energy generation is an effective solution to environmental and energy issues. However, there are some technical concerns of connecting renewable energy generation. Smart grid provides a technical platform for renewable energy grid integration.

Renewable energy generation could be installed either at the generation side, such as large wind farms and solar farms, or at the customer side as distributed generation (DG). Distributed generations refer to those small-scaled

generators installed close to customers. DGs are usually clean energy or renewable energy based generators, such as, combined heat and power (CHP), micro turbine, fuel cell, wind turbine and photovoltaic panel, etc. To a traditional power grid, the concern of connecting DGs to the distribution network is the reverse power flow from DGs to the grid when a local microgrid generates more power than it consumes. Traditional protection schemes need to be re-designed to accommodate the bi-directional power flow.

Clean Energy and Environment

Large-scale renewable energy generation connecting to power grid is constrained by the security and reliability operation requirements of power systems. Renewable energy, e.g. wind and solar, has intermittent characteristics. The generations of wind farm and solar panels are unstable and uncontrollable. Although power system automatic generation control (AGC) and spinning reserve capacity can compensate some load deviations in a short term, the sudden changes of power outputs due to intermittent wind power and solar energy require a much higher amount of compensation in a short time. The traditional AGC and reserve criteria may not be enough. More ancillary services and fast generation compensations are needed. A large installed capacity of wind turbines could also cause voltage problems and harmonic issues. Until these technical issues are solved, the total capacity of wind farm connecting to a power grid will be limited under certain penetration levels.

Energy storage is the solution to compensate intermittent renewable energy generation once practical and inexpensive energy storage methods are developed maturely. Electric energy could be stored mechanically through pump storage, compressed air, and fly wheel; or stored electro-magnetically through superconducting magnetic storage, and super-capacitor; or stored electron-chemically through lead-acid battery, flow battery and other advanced battery technologies.

Large-scale energy storage system could be installed at the generation side coordinating with wind and solar generation. For example, a combined renewable energy system with wind farms, solar panels and storage systems (e.g. pump storage station) will provide a stable output profile of renewable energy to the power grid. A well-developed storage system could also be used to provide ancillary services to power grid. The optimization and coordination of renewable energy generation and storage charging and discharging is a key issue of improving the energy efficiency of the combined renewable energy system. The other challenge is developing mature storage techniques that are practical and inexpensive for large-scale storage usage.

Distributed energy storage as well as distributed renewable energy generation is the key component in customer demand response in addition to consumption pattern adjustments using smart meters. Battery is a popular storage method for distributed energy storage. The combination of small renewable energy generators and batteries could be used as a stand-alone system or used for grid-connected micro-grid system.

Electric vehicle (EV), especially EV to Grid (V2G) technique, is a very important issue in smart grid. EV could perform as generator as well as storage with a V2G control system. EV could be used for leveling peak load, and as a backup for power failure. EV is an effective means of street CO₂ reduction. V2G is a

Clean Energy and Environment

promising technique for the future. However, to use EV in a wide range, some issues need to be considered (1) a high penetration of EVs may affect the existing power system operation, a smart power grid should have the capability of accommodating high penetration of EVs; (2) standards need to be set to solve the problem of reverse power from EVs; (3) more charging stations and replacing stations are needed for drained batteries, so it is convenient for customers to use EVs.

Renewable energy and storage integration to power grid will provide a solution to energy and environmental issues. The coordination of

renewable, storage and EV will significantly reduce the fluctuation of renewable energy generation. However, there are some barriers of accommodating all generation and storage options in a power grid. The cost of owning these generation sources and storages are high. Consumers and investors may not be motivated to invest. The techniques of grid-connection with high penetrations are not mature. To break the barriers, the smart grid needs to have (1) applications and standards that support Plug and Play functionality; (2) operation and planning tools; (3) smart sensors and smart controllers; and (4) real-time pricing mechanisms.



Figure 4-5 EV to Grid (V2G) technology enables more EV applications in the future

4.5 Future Control Center and ICT Applications

Information and communication technologies (ICT) are the fundamental of power system automation. The existing power system automation consists of: supervisory control and data acquisition (SCADA), energy management system (EMS), distribution management system (DMS), distribution automation (DA), substation automation (SA), and feeder automation (FA), etc. Most utility companies started to construct their automation systems since 1980s. The automation techniques significantly improved system reliability and service of power supply.

In the past decade, the information revolution has changed human's living styles. Applying the latest ICT to power system automation will significantly improve the efficiency of energy usage, improve power quality and reduce total cost. According to the DOE, the capabilities of smart grid include: self healing, consumer participation, high quality of power, resist attack, accommodate diversified generation options, enable power market, optimize asset, and enable high penetration of intermittent generation sources [2]. ICT will be the

fundamental and necessary techniques to implement these functions of smart grid.

Substations are important nodes in a power grid that assemble all monitoring, protection and control devices. Substations also play a role as collecting data from feeders and consumers, and communicating information with upper level control centers. Smart substations widely dispersed in the grid are key elements of a smart grid. A smart substation should be equipped with accurate data measurement units and data analysis tools for online network analysis. The standard communications inside the station and among stations are also important for information exchange. Phasor measurement unit (PMU) will increase the accuracy of data measurement in power grid. The data measured by traditional remote terminal unit (RTU) is not synchronized. PMU data is synchronized by a global positioning system (GPS). A phasor data concentrator (PDC) collects data from PMUs and sends data to SCADA and wide area management system (WAMS). Using data from PMUs and applying wide area control, power system operating conditions can be accurately monitored and simulated; hence it is possible to forecast fault events before the event occurs. That will significantly increase the system security and reliability.



Figure 4-6 The System Control Center of CLP Power

The future control center, by applying smart grid technologies, will be able to monitor operation conditions of primary devices, diagnose fault events, clear faults before they occur, support demand response, support intermittent renewable generations using real-time on-line data analysis and system control.

4.6 Conclusions

Renewable energy and customer demand response are the major solutions of energy and environmental issues. Smart grid provides the platform for renewable energy integration to grid and customer participation. Latest information and communication technologies will improve power system operation through online data analysis and real-time control, hence improve power system security and reliability, and the quality of power supply. Various smart

grid technologies applied in power generation, transmission, distribution and consumption will change customers' life styles, improve energy consumption pattern and the environment of the earth.

References

- [1] A. Ipakchi and F. Albuyeh, "Grid of the Future", *IEEE Power and Energy Magazine*, March 2009.
- [2] "A system view of the modern grid", reported by the NETL Modern Grid Initiative, 2007. Available at: http://www.netl.doe.gov/smartgrid/referenceshelf/whitepapers/ASystemsViewoftheModernGrid_Final_v2_0.pdf

Section 2: New Energy



5 Micro-wind Turbine System in Urban Environment

Leung, D.Y.C.¹, Leung, M.K.H.², Gambarota, L.³ and Deng, Y.¹

¹Department of Mechanical Engineering, the University of Hong Kong, Hong Kong

²School of Energy & Environment, City University of Hong Kong, Hong Kong.
Motorwave Group (Holding) Ltd.

Abstract

Wind power is identified to be of great potential for extensive development in many countries to reduce the fossil fuel based power generation. Conventional three blades wind turbines are commonly used in locations with high wind energy density, while small wind turbines are developed for less windy locations such as urban areas and flat lands. An innovative micro wind turbine was developed to generate power in urban environment where wind speed is usually low. Differing from the traditional wind turbine that can be connected directly to the grid, this system is linked to a small generator and batteries, and mainly used for local applications. The advantage of the micro wind turbine is that, apart from its low cost, it can be propelled by a very low wind speed. Computation fluid dynamics (CFD) simulations have been conducted to help evaluate the performance of a single micro wind turbine.



Figure 5-1 Prof. Dennis Leung and the Micro Wind Turbine on a roof in HKU

5.1 Introduction

Global warming and climate change issues boost the development of renewable energy in the world over the past decade. Up to now more than 80 countries have setup targets for their own renewable energy futures, and enacted relevant renewable energy policies in order to reduce their carbon emissions [REN21]. Table 6-1 shows the renewable energy targets adopted by major countries. The figures indicate our great reliance on renewable energy in the next ten to fifteen years.

Clean Energy and Environment

Among various renewable resources, wind energy is considered to be the most feasible for fast development in many countries in both short and long term, and provides the main driving force for substituting electricity generated from coal-fired power stations. In the ten years from 2001 to 2010, the global wind power installed capacity rose from about 20 GW to 200 GW (Global Wind Energy Council). Over the years, wind energy technology has been developed in many new dimensions, such as aerodynamics, structural mechanics and mechanical engineering. Moreover, it is mainly developed in two directions: large-scale and small-scale [Jureczko et al. 2005]. The main trend of wind turbine development is to implement large-scale wind energy systems in offshore or land based wind farms where the wind energy density is high. The wind turbines used in these systems vary from several hundreds kW to several MW, with rotor diameters from several ten meters to over one hundred meters.

On the other hand, in regions of low wind speed and in crowded urban areas, miniature wind machines or micro wind turbines are more suitable due to the space limitation and low cut-in wind speed (the minimum wind speed for the wind turbines to produce electricity). A small wind turbine, with a rotor diameter as small as one meter or less, can often be set up and stand alone on the roof of houses and buildings. To make it more flexible for usage, this kind of wind energy converter is normally directly

linked to batteries or battery systems rather than connected to the electric grid. As its capacity is not big (usually <1kW), its prime cost is not very high and is affordable for many household applications. This small scale wind turbine has received attention in recent years and many research works have been conducted, mainly for optimization of their performance.

Countries	Renewable energy target	Year
EU*	20%	2020
U.S.A.	25%	2025
China	15%	2020
Australia	20%	2020
Russia	4.5%	2020
Japan	1.63%	2014

* Baseline target (may be different for different EU countries) (Data from Wikipedia 2011)

Table 5-1 Renewable energy target for major countries.

Various theoretical methods are available to determine the aerodynamic forces acting on the blades of a horizontal axis wind turbine (HAWT) [Wang et al. 2008], such as the Blade Element Momentum (BEM) theory [Varol et al. 2001, Jureczko et al. 2005, Lanzafame & Messina 2007], Lifting Line Method (LLM) [Duquette & Visser 2003], Lifting Surfaces Method (LSM) (de Bruin 2003), N-body/

particle simulation method, and asymptotic expansion method (Euler special) (van Busse 1995). Among them, the BEM method is the simplest and most commonly used for research purposes. In this paper the performance of a specially-designed low-cost micro wind turbine is evaluated using a computational fluid dynamics (CFD) technique which is verified with physical tests conducted in a wind tunnel. [Deng 2008]

5.2 Design of an innovative micro-wind turbine

The wind turbine under investigation is a drag device based micro wind turbine, as shown in Fig. 5-2 and 5-3. Different from conventional two- or three-blade wind turbines, this micro wind turbine employs a fan-type blade configuration instead of an aerofoil-type. This has a functional advantage of increased power efficiency for micro wind turbine [Hirahara et al. 2005].

The edgewise view defines the blade thickness distribution over the blade length. Many large wind turbines utilize linear taper blades from the root to the tip for rigidity [Habali & Saleh 2000]. Since the blade of the micro wind turbine is not very long, it is designed to be in mono thickness along the blade length. Similar to most wind turbines, twisted blades are used to capture higher torque under different wind conditions.

The twist extent of the turbine blade is clearly displayed in the transaction view. The twist

angle of the micro wind turbine is a critical parameter for the present computation and optimization work, and it has a strong relationship with the blade subtend-angle of the micro wind turbine. Important geometric parameters of a typical micro wind turbine are shown in Table 5-2.



Figure 5-2 Micro wind turbine under studying

The advantage of this micro fan-bladed wind turbine design is that a system, consisting of multiple turbines connected together through their external gears, can be easily setup to meet any power demand in a flexible manner (see Section 5.4). Such blade and turbine designs can be produced by injection molding for mass

production; therefore the cost of the system is only about one third of conventional wind turbine system designs.

Description	Value
radius of the micro wind turbine	117 mm
radius of the blade tip circle	115 mm
radius of the blade root circle	50 mm
blade subtend-angle (the angle between the two edges of the blade in the front view) (α)	30°
twist angle of the turbine blade (the angle between the chord line of the blade tip and that of the blade root) (β)	21°
width of the blade area (Z)	60 mm
number of blade (N_B)	8
Solidity (Σ) ($\sigma = N_B \times A_s / \pi R^2$)	52.2%

Table 5-2 Geometric parameters of a typical micro wind turbine.

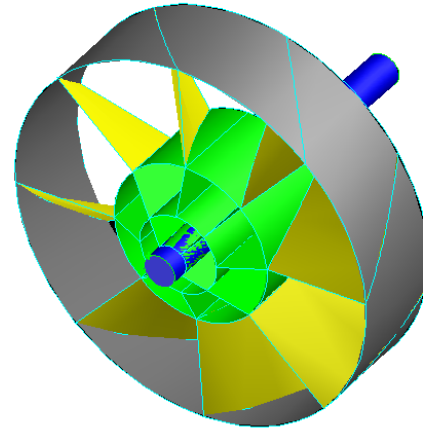

Figure 5-3 Micro wind turbine (CAD design)

5.3 Factors to be considered in the design of a micro-wind turbine

Many factors such as the effect of blade subtend-angle of the turbine and number of turbine blades may affect the power coefficient of the wind turbine. A number of simulations were conducted by the CFD to obtain the followings:

- (i) the maximal angular velocity of the micro wind turbine at different wind speeds;
- (ii) the torque acting on the micro wind turbine when they are stationary and

rotating at a certain angular velocity at different wind speeds;

- (iii) the mechanical energy produced by the micro wind turbine at different wind speeds.

For demonstration, a few cases are presented and discussed in this paper. More information can be found in Deng [2008].

5.3.1 Tip speed ratio

Figure 5-3 shows the computed relationship between the power coefficient (C_p) and the tip speed ratio (λ) of the micro wind turbine. It is recognized that small-scale multi-bladed wind turbines normally operate at a tip speed ratio between 0 to 2 while the large-scale one with two or three blades operates at a tip speed ratio higher than 4 [Johnson 1985]. As indicated, the tip speed ratio of the present micro wind turbine with a 30-degree blade subtend-angle is between 0 and 1, which meets closely with the C_p - λ characteristic of the traditional, small, multi-bladed wind turbine. Besides, the maximal power coefficient of the micro wind turbine indicates that the efficiency of the transformation from kinetic wind energy to mechanical energy is only about 12%.

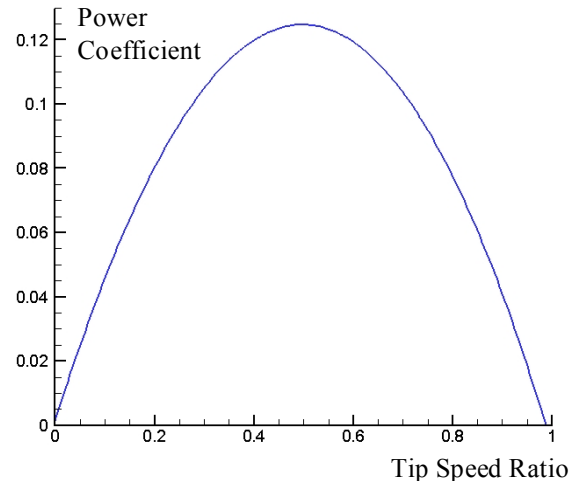

Figure 5-4 Characteristic of the micro wind turbine

5.3.2 Effect of blade subtend-angle

To compare the performance of the micro wind turbine with different blade profiles, they were categorized into several series according to their blade subtend-angle. For each series, the blade number varied from three to a number at which the blade plane of the turbine is covered by the blade projection.

For the blades with 30-degree subtend-angle, the blade number varied from three to twelve. No significant difference in the maximal power output can be observed for the micro wind turbines with eight or more blades as shown in Figure 5-4, while their maximal power outputs are much higher than those turbines with fewer

blades. The optimal power coefficient of the turbines with a 30-degree blade subtend-angle is about 12.5% while the optimal tip ratio is 0.5 ~ 0.6 for the 8-bladed to 12-bladed profile. Another important factor indicated in this figure is that the maximal tip speed ratio of the micro wind turbines with different blade numbers is about the same.

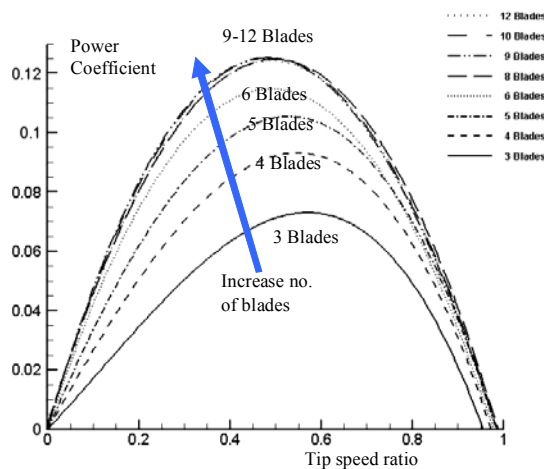

Figure 5-5 Power coefficient with different number of blades with 30-degree blade subtend-angle.

To determine which one of these wind turbine blade designs is optimal, the captured torque for starting the turbine needs to be considered. The larger the torque developed, the easier to overcome the static equilibrium of the turbine. Figure 5-5 shows that there is no obvious

difference in the captured torque of the micro wind turbines with eight or more blades. On the other hand, a rotor with fewer blades captures a smaller torque, which is not favourable for energy conversion.

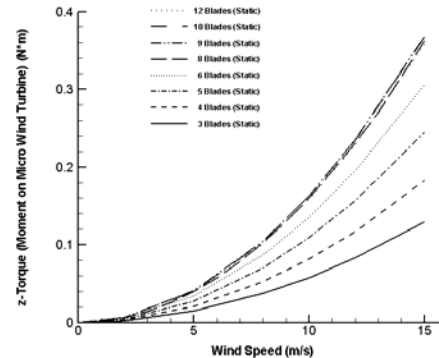

Figure 5-6 Starting effect (torque) with different number of blades (with 30-degree blade subtend-angle)

The results of other blade subtend-angle can be found elsewhere [Deng 2008]. In general, for a given blade subtend-angle, more blades yields a better performance. However, a fully-occupied rotor plane is not beneficial for both power output and starting effect of micro wind turbine. Moreover, a blade with a subtend-angle larger than 90-degrees is not recommended for micro wind turbine design due to its poor starting performance.

5.3.3 Effect of Solidity

Figure 5-6 shows the relationship between the maximal power coefficient and the solidity of the micro wind turbine. The figure illustrates that the maximal power coefficient of the turbine rises with increase in solidity, and then becomes fairly constant for solidity higher than 0.5. In other words, it is better to select a micro wind turbine profile whose solidity is higher than 0.5 to receive a higher power output.

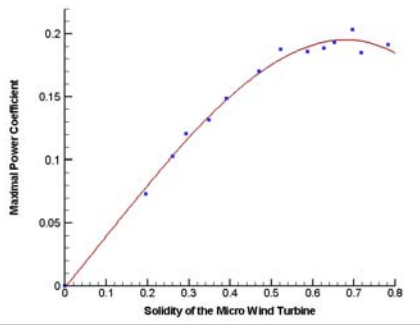

Figure 5-7 Relationship between maximal power coefficients with the solidity

According to the results, the 4-bladed micro wind turbine with 80-degree blade subtend-angle has the highest power coefficient. However, this is not the optimal profile for the micro wind turbine due to its comparatively weak starting torque. Figure 5-7 shows the torque produced by those high-efficiency wind turbine profiles under stationary condition.

Among these rotors whose power coefficients are higher than 0.18, the 5-bladed rotor with 60-degree blade subtend-angle is considered to be the optimal micro wind turbine profile. Compared with that of original micro wind turbine profile (30-degree blade subtend-angle, 8-bladed), the maximal power coefficient of the 5-bladed rotor with 60-degree blade subtend-angle raises from 12.5% to 19.3%.

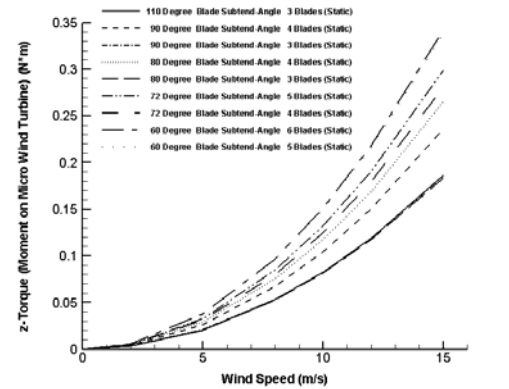

Figure 5-8 Starting effects of several high-power-coefficient micro wind turbines

5.4 Micro-wind turbine system

Section 5.3 describes the performance of a single micro-wind turbine which can develop a finite power even at high wind speed. To increase the power, a number of this micro-wind turbine can be connected together through its external gears so that a larger torque, hence higher power, can be developed (Figure 5-8).

Clean Energy and Environment

No. of turbines (n)	Increase in power (%)
1	0
2	132
3	275
4	436
5	525

Table 5-3 Increase in power with increasing the number of turbine

Wind speed (m/s)	Power (W)
2	0.4
3	1.3
4	3
5	6
6	10
7	17
8	25
9	36
10	50

Table 5-4 Power obtained for a 8-micro-wind-turbine system at various wind speeds.

An experiment has been conducted in the wind tunnel to find the relationship between the

power developed and the number of wind turbine connected in a straight line. Table 5-3 shows the increase in power with increasing number of turbine at a wind speed of 6.5 m/s.

As can be observed, the power increases with increasing the number of turbines. However, it was found that the increase is not linear, particularly for the number beyond 5 and there is no power increase for $n > 10$ [Leung 2009]. It is therefore recommended that not more than 10 micro-wind turbines should be connected together serving one generator for maximizing the power generation capability.

Table 5-4 shows the power generated at different wind speeds measured in an environmental wind tunnel. As can be observed, power can be generated at a low wind speed and the magnitude increases quickly at larger wind speeds. Useful power can be obtained if a number of these micro wind turbines can be grouped together for power generation.



Figure 5-9 Wind tunnel test of micro wind turbine system.

5.5 Conclusions

This study investigates the variation of the performance of micro wind turbine with different design parameters using CFD analysis. The results showed that the performances of high-solidity wind rotors are better than those of low-solidity ones. The optimization results show that the preferable solidity of the micro wind turbine is higher than 50%. Through the CFD analysis, it is found that rotors with more blades can produce higher torque when they are stationary. As a result, a multi-blade approach is favorable for a micro scale wind turbine system. The 5-blade micro wind turbine with 60-degree

blade subtend-angle is found to be the optimal turbine profile with the consideration of the power coefficient and starting effect. Its maximal power coefficient is much higher than that of the preliminary turbine design (8-bladed rotor with 30-degree blade subtend-angle) and its higher power coefficient range is much wider.

References

1. de Bruin A.C. 2003. S-Wake Assessment of Wake Vortex Safety National Aerospace Laboratory NLR
2. van Busse G.J.W., 1995. The aerodynamics of horizontal axis wind

- turbine rotors explored with asymptotic expansion methods. PhD dissertation, Delft University of Technology.
3. Deng Y., 2008. MPhil thesis, Design Optimization of a Micro Wind Turbine using Computational Fluid Dynamics. The University of Hong Kong, 169 pp.
 4. Duquette, M. M., Visser, K. D., 2003. Numerical Implications of Solidity and Blade Number on Rotor Performance of Horizontal-Axis Wind Turbines. *J. Solar Energy Engineering*, November 2003, 125, 425-432.
 5. Habali, S. M., Saleh, I. A., 2000. Local design, testing and manufacturing of small mixed airfoil wind turbine blades of glass fiber reinforced plastics Part I: Design of the blade and root. *Energy Conversion & Management* 41, 249-280.
 6. Hirahara, H., Hossain, M. Z., Kawahashi, M., Nonomura, Y., 2005. Testing basic performance of a very small wind turbine designed for multi-purposes. *Renewable Energy* 30, 1279-1297.
 7. Johnson, G. L., 1985, *Wind Energy Systems*, Prentice-Hall, Englewood Cliffs, New Jersey.
 8. Jureczko, M., Pawlak, M., Męzyk, A., 2005. Optimization of wind turbine blades. *Journal of Materials Processing Technology* 167, 463-471.
 9. Lanzafame, R., Messina, M., 2007. Fluid dynamics wind turbine design: Critical analysis, optimization and application of BEM theory. *Renewable Energy* 32, 2291-2305;
 10. Leung, W.K., 2009, *Micro-wind Turbine*, BEng dissertation, the University of Hong Kong, 71 opp.
 11. REN21 (2010). *Renewables 2010 Global Status Report*,
 12. Varol, A., İlkılıç, C., Varol, Y., 2001. Increasing the efficiency of wind turbines. *Journal of Wind Engineering and Industrial Aerodynamics* 89, 809-815.
 13. Wang, F., Bai, L., Fletcher, J., Whiteford, J., Cullen, D., 2008. The methodology for aerodynamic study on a small domestic wind turbine with scoop. *J. Wind Eng. Ind. Aerodyn.*, 96, 1-24.

6 Thin Film Solar Cells

Wallace C.H. Choy

Department of Electrical & Electronic Engineering, University of Hong Kong, Hong Kong, China

6.1 Types of Thin Film Solar Cells

The demand for energy, especially for Electricity, ascended to the historical high these few years, and it will keep increasing gradually next 25 years [1]. Although thermal power technology by burning coal is mature with abundant experience in operation and maintenance, severe air pollution and release of warm-house gases to the atmosphere cannot be prevented. With the world's ever growing population and thinning of planet's resources, scientists working against time to develop new methods of generating renewable energy efficient enough to supply the world's demand. Photovoltaics, a method of generating electrical power by converting solar radiation into direct current (d.c.) electricity, is one of the promising methods. This chapter reviews one sub-field of photovoltaics –thin film solar cells particularly organic thin film solar cells.

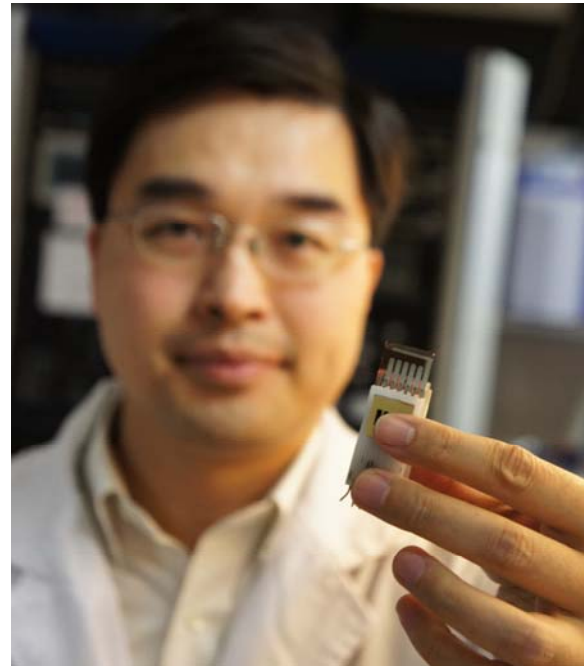

Figure 6-1 Dr. Wallace Choy and the organic thin film solar cell developed by his team

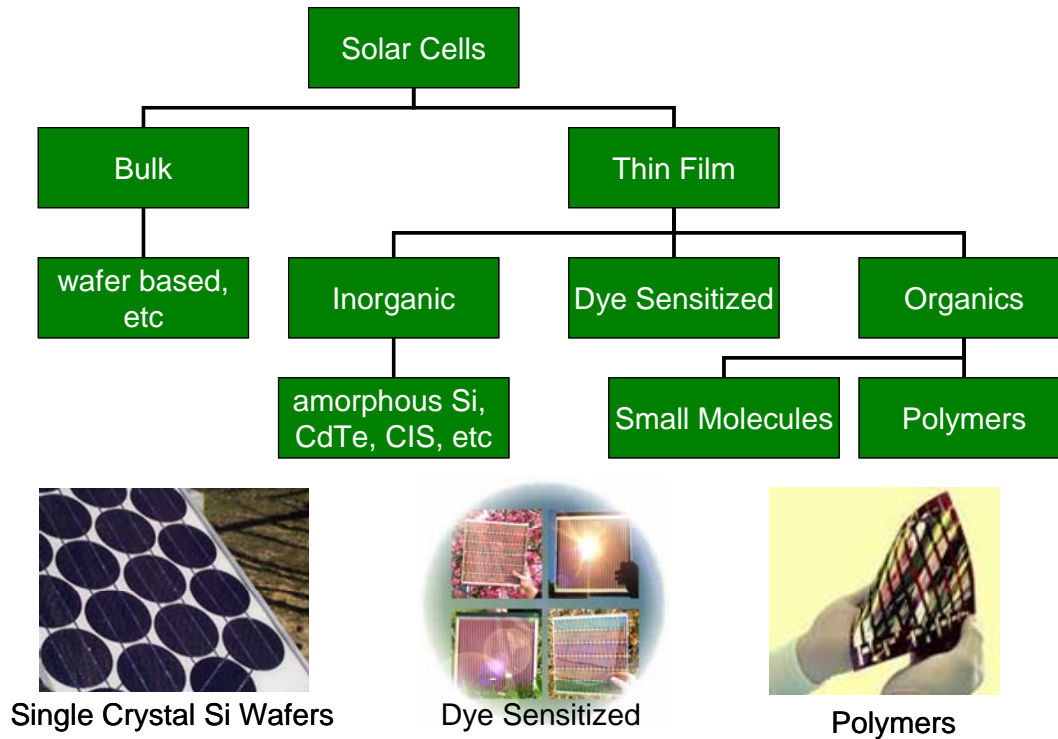

Figure 6-2 Various solar cells.

Figure 6-2 summarizes various types of solar cells that are currently available in markets or in development. The market share of thin film solar cells is about 10 to 15% comparing to which the crystalline silicon (c-Si) PVC dominates 85 to 90% of the market [1]. Thin film solar cells can be further divided into 3 groups: i) inorganic solar cells such as amorphous Si (a-Si), Cadmium-Telluride (CdTe), Copper-Indium-Selenide (CIS), Copper-Indium-Gallium-Selenide (CIGS) etc,

(ii) dye-sensitized solar cells (DSCs), and (iii) organic solar cells including small molecules and polymers.

While conventional bulk solar cells are around millimeters (mm) thick and typically are bulk single or poly-crystalline materials, thin film solar cells are made with less material and its thickness is only up to tens of micrometers [2]. Thin film solar cells also weigh lighter than the bulk solar cells which can also ease and simplify

the transportation and installation. Besides, thin film solar cells have high degree of freedom to be rolled-up such that its shape flexibility can be applied on most products with polished curves.

6.1.1 Inorganic Thin Film Solar Cells

Amorphous Silicon: This type of thin film solar cells is typically made by chemical vapor deposition. Similar to the c-Si PV, group III and group V materials are doped into different regions of the silicon film to form a p-n junction. When the sunlight irradiates on the cell, photons are absorbed by electrons of the active region, the electrons are excited to the conduction band from the valence band. If a load is connected, this electron will flow into the load circuit and back to the p-type junction to compensate the holes flowing through the depletion region.

Since the a-Si is a defective material that crystalline is not formed appropriately, its band gap energy is 1.7eV which is higher than 1.1eV of the c-Si. It results that the a-Si can absorb a wide (wavelength) range of photons at the visible light of the solar spectrum, particularly in the blue/violet light region; however, it also means that it would absorb less in the infrared region comparing to the c-Si. On the other hand, the numbers of the effective electron-hole pair excited by the incident photons are reduced and the connections between the silicon atoms are not in order; hence the efficiency of this type of thin film solar cells is theoretically less than the c-Si.

The highest initial efficiency is about 10%. However, its efficiency would degrade after experiencing the sunlight. The drop would be ranging from 15% up to 35%. Studying of the efficiency after expected degradation is necessary for selecting this technology.

Thin Film Chalcogenide: The Ca-Te, the CIS and the CIGS thin film solar cells belong to this type of film. Its operation principle is very similar to the a-Si but no p-n junction is formed. Instead of doping impurities into the silicon, this type of film contains donors and acceptors. The donors of Ca-Te, CIS and CIGS are telluride, selenide and selenide, and their acceptors are cadmium, copper and copper, respectively.

When the sunlight irradiates on the film, the donor's outer shell electrons are excited. By connecting to a load circuit, current will be generated as what a-si film performs. The highest efficiency is about 13% and it achieves the steadiest and highest efficiency among various thin film solar cells.

The CdTe (1.45eV) is a p-type material, it usually form a hetero-junction with CdS (2.4eV). The formed hetero-junction experiences poor PV properties and therefore special treatment such as thermal annealing shall be applied to prevent the inter-diffusion of S in order to limit the shunting of the device. Another issue is about the electrode of the CdTe layer. A Schottky contact is usually formed due to the work function of CdTe higher than the metal ohmic contact. A buffer layer is applied to

overcome this problem. $\text{Sb}_2\text{Te}_3/\text{Mo}$ and Sb/Mo contacts are introduced to provide high efficiency and long time stability.

The CIS has relatively low bandgap (1eV), and therefore Ga alloy is usually added to form CIGS to get higher bandgap and hence the open circuit voltage. Its limitation is due to the rare source of indium and gallium although this type of thin film solar cells exhibits many advantages such as high optical absorption with very thin thickness (0.1 to 0.3 μm), mixture of different solid solutions to allow bandgap engineering and allowance to change its conductivity. The popular electrode on the substrate is still Molybdenum (Mo) layer for the industrial products. Meanwhile, a n-type buffer layer which has bandgaps between 2.0eV to 3.4eV is usually applied between the top transparent electrode and CIGS to enhance the efficiency.

6.1.2 Photochemical thin film solar cells

The dye-sensitized solar cell belongs to this type of film. A typical Dye-cell is Grätzel's cell, invented by Michael Grätzel, the director of the Laboratory of Photonics and Interfaces at École Polytechnique Fédérale de Lausanne in Switzerland. The molecular dye which can absorb the sunlight is laid on porous transparent titanium dioxide (TiO_2) nano-particles layer at the top of the cell. The titanium oxide acts as a transparent electrode. A counter electrode with a reflective layer is placed at the bottom of the cell. There is electrolyte such as copper iodide in-between them. When the sunlight passes

through the TiO_2 and arrives at the dye, the photons excite the dye. The excited dye (dye*) would then inject electron into the conduction band of TiO_2 . After that, the electrons diffuse inside the electrode and flow through the external load circuit and back to the counter electrode.

Meanwhile, the dye* molecular take away an electron from iodide in the electrolyte to prevent its decomposition, and the iodide is then oxidized to be triiodide, I_3^- . I_3^- would then diffuse to the counter electrode and get back the electron from the external load circuit to become iodide. This cycle keeps continue under the sunlight and produces energy to power up the load circuit.

This electron injection process is unlike the p-n junction. For the p-n junction, electron-hole pair is generated by photon; however, the excited dye does not generate electron-hole pair but free electron only. There is no loss of electron recombine with hole. The highest efficiency of this type of thin film solid cells is about 10%.

One of the major problem of dye-sensitized solar cells is about using the liquid electrolyte. The liquid would freeze under low temperature and expand under the high temperature. Both of the situations would damage the physical structure of the cell. The former one would even terminate the electricity conversion process. In recent developments, replacing of the liquid electrolyte with a solid is current hot topic. Solidified melted salt is one of potential

substitute, but it suffers from high degradation during continued operation.

6.1.3 Organic Thin Film Solar Cell

Polymer solar cells (PSCs) are the potential candidate for the next generation photovoltaic devices due to their low fabrication costs, flexible processing methods and large area applications [3-5]. In the past few years, many efforts have been made to improve the device performance towards 10% efficiency for commercialization. In fact, the efficiency of over 8% has been achieved [6].

Among the thin film solar cells, organic thin film solar cells have been gaining interest increasingly in the last decade. Recent advancement in screen printing technology makes low cost mass production of organic thin film solar cells possible. Organic thin film solar cells can use wet processing technique instead of the vacuum deposition technique used in traditional solar cell fabrication. Vacuum deposition technique requires costly fabrication conditions and processes. [7]

Unlike traditional solar cells, organic solar cells typically do not have p-type and n-type doped semiconductors. Instead, organic cells are made up of donors and acceptors:

- (i) Donor - A material with lower ionization potential, a quality defined by the highest occupied molecular orbital (HOMO), meaning it gives electrons easily.

- (ii) Acceptor - A material with higher electron affinity, a quality defined by the lowest unoccupied molecular orbital (LUMO), meaning it has a strong electrons attracting force.

We can use 5 steps to describe the operating mechanism of organic solar cells. They are i) exciton generated by absorbing the photons; ii) exciton diffusions among the organic molecular; iii) charge separation, iv) charge transportation, and v) charge collection at the electrode.

For the organic molecular, exciton, electron-hole pair, could be generated by either the donor or the acceptor. Like the p-n junction, not the whole spectrum of the sunlight could be absorbed by the organic molecular, the most absorption region ranging from the red light to the violet light. Besides, the generated electron-hole pair could re-combine and release the photon or other form of energy in a very short time.

After that, the generated excitons will diffuse to anywhere but the diffusion length is around 10nm only. During this process, the electron-hole pairs will experience trapping by the molecular or re-combination such that the effective excitons are decreased.

When the excitons arrive at the interface of the donors and acceptors, the electron and the hole would be separated. The energy required is above 0.4eV which is the difference between the

lowest unoccupied molecular orbital (LUMO) energy level of the donor and acceptor.

After separation, the charge would then diffuse to anode and cathode, respectively. At this moment, charge may also be trapped or recombine to further decrease the generated current of the cell. When the charges can reach the electrode and be collected, electricity will be generated. Consequently, we can then develop

an equation to describe the organic solar cell external quantum efficiency (EQE): $EQE = \eta_{abs} \eta_{ED} \eta_{tc} \eta_{cc}$. They refer to the efficiency of the above 5 steps in which η_{abs} is the light absorption (or exciton generation) efficiency, η_{ED} is the exciton diffusion efficiency, η_{tc} is the charge transfer (or exciton dissociation) efficiency and η_{cc} is the charge collection efficiency showing the charge transfer and collection.

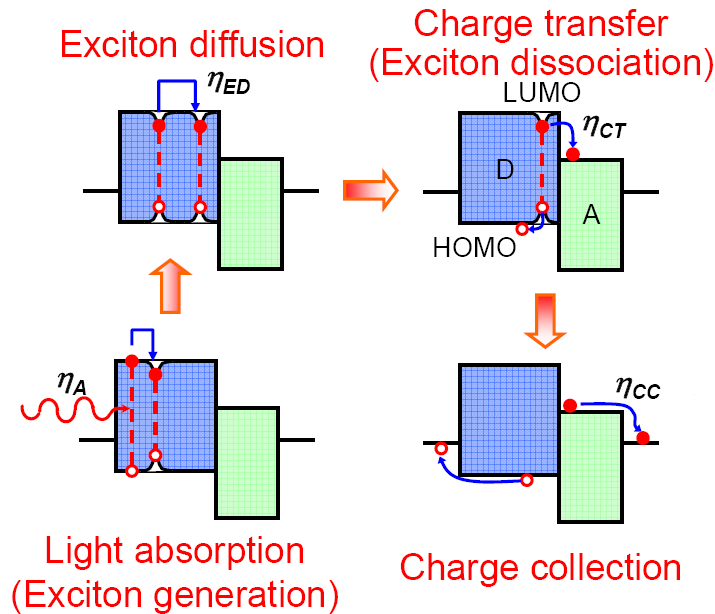

Figure 6-3 The operation mechanism of an organic solid cell. Donors and acceptors are denoted by D and A respectively

The biggest drawback for organic solar cells is their low carrier mobility and the short diffusion length of excitons. To efficiently transfer

charges, both donors and acceptors need to be much thinner than 1 micron. However, as mentioned above, reducing cell thickness

decreases power efficiency. This is because less light is absorbed. To ensure that the majority of excitons reach to the donor-accepter interface before the recombination, bulk-heterojunction polymer solar cells are developed. Instead of having one layer or donor and one layer of acceptor as the basic organic cells mentioned above, bulk-heterojunction organic solar cells have one interconnected layer of nano-size donor and acceptor materials. The interconnected materials, being separated in phase make up an inter-penetrating network. Not only does this largely increase the surface area of the interface, it also shortens the excitons

travel distance to just nanometers, which is within the diffusing range of excitons and therefore enhance the power efficiency [8].

Another advantage of organic solar cell is the possibility of tuning their absorption resonance [9]. Figure 6-4 shows the Reference Solar Spectral Irradiance (Air Mass 1.5), which basically describes the distribution of solar power of different wavelength in the atmosphere. The graph shows that a big portion of sunlight is made up of electromagnetic waves with wavelengths ranging from 400nm to 700nm.

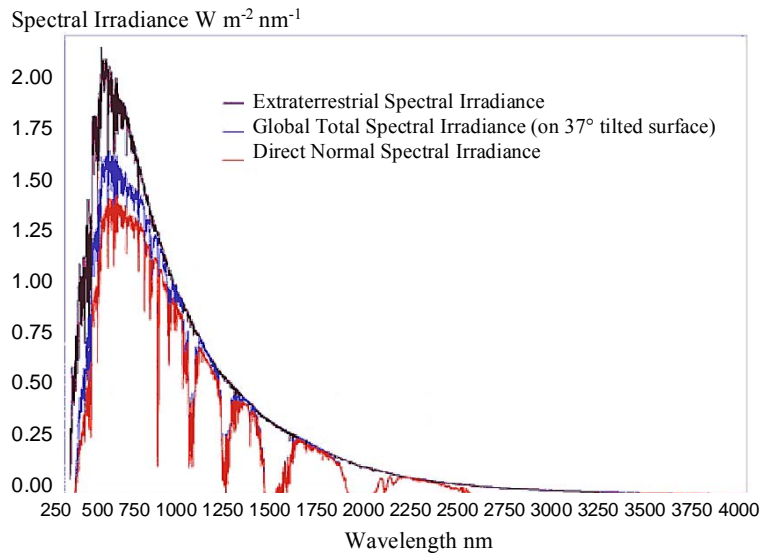

Figure 6-4 Reference Solar Spectral Irradiance: Air Mass 1.5 [10].

The plot presents measurements of sunlight in watts in 1m² of surface area for 1nm of bandwidth. The black line represents the Extraterrestrial Spectral Irradiance, blue line as Global Total Spectral Irradiance (on 37° tilted surface), and red as Direct Normal Spectral Irradiance.

The high intensity of visible and infrared waves from sun light makes it desirable to fabricate solar cells that absorb the correspondent region of the spectrum efficiently. The technology in tailoring polymers is already so mature that by simply changing the length or function group of the polymer can change its bandgap and ionization properties.

Another way to enhance the efficiency is to improve light harvesting by the use of metallic nanostructures. Scientists use the surface plasmonic effect in dielectric-metal interfaces to absorb lights of certain frequencies. Absorptions only occur in the frequency where dispersion

relation of the photons coincides with that of the surface plasmon resonance. Previous analysis has shown that for there to exist an intercept on the 2 dispersion relations, the lights must be shown from the metal side. Metal, however is only transparent for thickness smaller than its penetration depth, which is generally in nanoscales. This is why nanoscale structures are used for enhancing the light absorption at certain frequencies in solar cells. Varying the size, shape, geometry and spacing of the nanostructures can be tuned the plasmonic resonance frequency, full-width at half-maximum and possible add absorption peaks to improve the performance of organic solar cells.

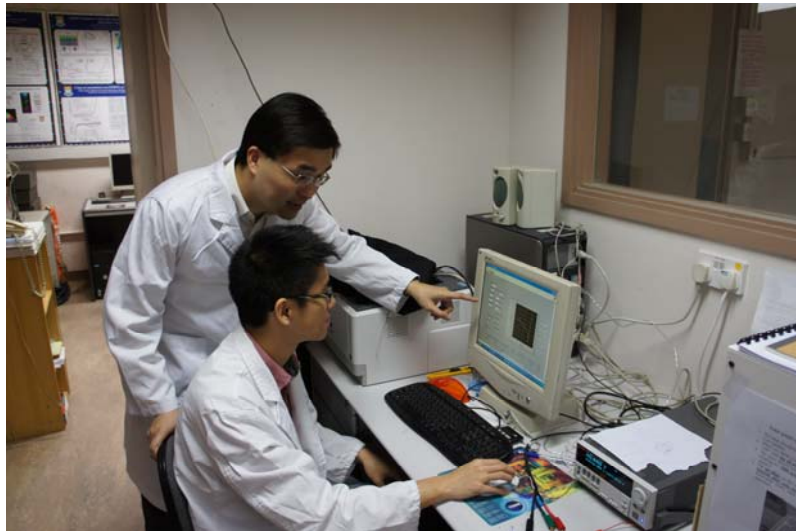

Figure 6-5 Dr. Wallace Choy's team measures the efficiency for light harvesting improvement

To fully utilize the high intensity part of the spectrum, tandem solar cells have been developing [11]. With the use of transparent anode and cathode, cells of different absorbing wavelength can be stacked to form tandem solar cells, which absorb a large range of spectrum.

Recently, groups from the Clarendon Laboratory from the University of Oxford, Material Science and Engineering Department from the Cornell University of New York, and Center for Nano Science and Technology of IIT from Milano have collaborated to study the effect of incorporating metal nanoparticles in dye sensitized solar cells. [12] In dye sensitized solar cells, photo sensitive dyes are used for photoelectron generation, while the semiconductor surrounding the dye is used for transporting carriers and separating the anode and cathode. The teams' goal is to improve efficiency by using the field enhancement property of nanoparticles. An issue with this approach is that the nanoparticle, being metal, is corrosive, and can act as a recombination site to the system. The teams found that by adding a thin SiO₂ shell around the Au nanoparticle can prevent the unwanted charge exchange, while enhancing the absorption. The shell also helps keeping the nanoparticle and the dye a moderate distance away that they are close enough for the dye to take advantage from the near field absorption enhancement while not too close to interfere with the dye's optical property. Their result was a double absorption in the 500nm range.

Recently, some work has been conducted to use the metallic nanostructures to improve the performance of organic solar cells [13]. Typically, OSCs [14] have planar multilayered structures which can support waveguide modes. As an example, the active regions of conventional small molecule solar cells [14] are composed of fullerene (C₆₀) and some organic (small molecule) materials such as copper (II) phthalocyanine (CuPc), and bathocuproine (BCP), which are different from that of polymer solar cells. When the metallic nanostructures are integrated with the multilayered organic device structures, apart from the plasmonic resonances and waveguide modes, some other optical modes will be generated in the integrated structures [15]. The optical modes include, for example, Floquet modes which depend on the periodicity of the ordered metallic nanostructures, cavity modes which are also a kind of waveguide modes and depend on the geometry of one period of the ordered metallic nanostructures, and leaky modes which depend on the geometry of the metallic nanomaterials in the nanostructures. With the further optimization of the device structures, the performance of organic solar cells can be continuously improved for contributing to practical photovoltaics.

Reference

- [1] Technology Road Map – Solar Photovoltaic Energy, International Energy Agency

- [2] <http://www.solarserver.com/knowledge/basic-knowledge/photovoltaics.html>
- [3] N.S. Sariciftci, L. Smilowitz, A.J. Heeger, F. Wudl, *Science*, 258, 1474, 1992.
- [4] J. Huang, G. Li, Y. Yang, *Adv. Mater.* 20, 415, 2008.
- [5] F.C. Krebs, *Sol. Energy Mater. Sol. Cells*, 93, 394, 2009.
- [6] <http://www.solarmer.com>
- [7] http://cvitae.org/images/stories76/Organic_SolarCells-EHE.pdf
- [8] *Semiconducting Polymers: Chemistry, Physics and Engineering*, vol. I, 2nd Edition, Conjugated Polymer-Based Organic Solar Cells.
- [9] <http://www.brighthub.com/environment/renewable-energy/articles/95572.aspx>
- [10] <http://tredc.nrel.gov/solar/spectra/am1.5/>
- [11] S. Sista, M. Park, Z. Hong, Y. Wu, J. Hou, W.L. Kwan, G. Li, Y. Yang. *Adv. Mat.*, 22, 380, 2010; S. Sista, Z. Hong, M. Park, Z. Xu, Y. Yang. *Adv. Mat.*, 22, E77, 2010.
- [12] M.D. Brown, T. Suteewong, R. Sai Santosh Kumar, V. D’Innocenzo, A. Petrozza, M. M. Lee, U. Wiesner, and H. J. Snaith, *Nano Letters* DOI: 2010 10.1021/nl1031106
- [13] S. B. Rim, S. Zhao, S. R. Scully, M. D. McGehee, and P. Peumans, *Appl. Phys. Lett.* 91, 243501 (2007); T. H. Reilly III, J. van de Lagemaat, R. C. Tenent, A. J. Morfa, and K. L. Rowlen, *Appl. Phys. Lett.*, 92, 243304, 2008; W. C. H. Choy, "Plasmonic Effects on Organic Solar Cells and LEDs", *Photonic Global Conference 2010*, Singapore. Dec 2010; C.D. Wang, W.C.H. Choy, *Solar Energy Materials and Solar Cells*, 95, 904, 2011.
- [14] See for instance, C.W. Tang, *Appl. Phys. Lett.*, 48, 183 1986; P. Peumans, A. Yakimov, and S. R. Forrest, *J. Appl. Phys.*, 93, 3693 (2003).
- [15] W. E.I. Sha, W. C.H. Choy, and W. C. Chew, "The Angular Response of Thin-Film Organic Solar Cells with Periodic Metal Back Nanostrips", *Opt. Lett.*, accepted; Wei E.I. Sha, W.C.H. Choy, and W.C. Chew, *OSA Optics Express*, 18, 5993, 2010.

一充即動 為環保充電
PLUG & DRIVE

Section 3: Carbon Reduction



Electric Vehicles

Prof. K.T. Chau

International Research Centre for Electric Vehicles

Department of Electrical and Electronic Engineering, The University of Hong Kong



7.1 Introduction

In the past, there were various definitions of electric vehicles (EVs). They used to be classified into two types: the pure EV which was purely powered by batteries and only propelled by an electric motor, and the hybrid EV (HEV) which was powered by both batteries and liquid fuel and propelled by both the engine and the electric motor. After the invention of other energy sources, namely the fuel cells, ultracapacitors and ultrahigh-speed flywheels (Chau *et al.*, 1999), this classification became inappropriate. In recent years, there has been a consensus that the EVs refer to vehicles with at least one of the propulsion devices being the electric motor. Then, when the energy source is only batteries and the propulsion device is only an electric motor, they are named the battery EV (BEV) or even loosely called the EV; when the energy source involves fuel cells working together with batteries and the propulsion device is only an electric motor, they are named the fuel cell EV (FCEV) or simply called the fuel cell vehicle; when both batteries and liquid fuel are the energy sources as well as both the engine and the electric motor are the propulsion devices, they are named the hybrid EV (HEV)

or simply called the hybrid vehicle. Figure 8-1 depicts the classification of the existing internal combustion engine vehicle (ICEV), HEV, BEV and FCEV based on the energy source and the propulsion device.

The first EV, actually a BEV, was built by Thomas Davenport in 1834. With the drastic improvement in the ICEV, the BEV almost vanished from the scene by the 1930's. The rekindling of interests in BEVs was resulted from the outbreak of energy crisis and oil shortage in the 1970's. The actual revival of BEVs was due to the growing concerns on energy conservation and environmental protection throughout the whole world in the 1990's. In essence, BEVs offer higher energy efficiency, better energy diversification, load equalization of power systems, zero local exhaust emissions and quieter operation than ICEVs. However, there are two major barriers hindering the popularization of BEVs — short driving range and high initial cost. These barriers can not be easily solved by the available energy source technologies (including batteries, fuel cells, ultracapacitors and ultrahigh-speed flywheels) in the near future.

People may not buy a BEV, no matter how clean, if its range between charges is only one hundred kilometres. By the same token, people may not buy a FCEV, no matter how clean, if its price is over ten times the ICEV counterpart.

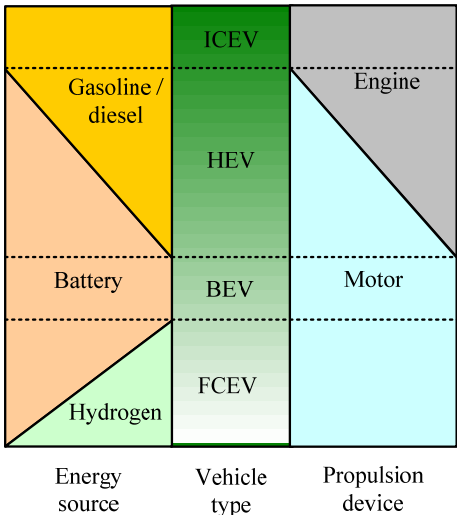

Figure 7-1 Classification of vehicles.

The HEV, incorporating the engine and the electric motor, was introduced as an interim solution before the full implementation of pure EVs at which there is a breakthrough in energy sources. The distinctive advantages of the HEV are to greatly extend the original BEV driving range by two to four times, and to offer rapid refuelling of liquid fuel. An important issue is that it does not require any change in the refuelling infrastructure. The key drawbacks of the HEV are the loss of zero-emission vehicle concept and the increased complexity. Nevertheless, the HEV is vastly less polluting and exhibits less fuel consumption than the ICEV while having the same range. These merits are due to the fact that the engine of the HEV can always operate in its most efficient

mode, yielding low exhaust emissions and low fuel consumption (Chau *et al.*, 2007). Also, the HEV can be purposely operated as a BEV in the zero-emission zone. It is becoming a consensus that the HEV is not only an interim solution before the implementation of pure EVs but also a practical solution for realization of the class of super-ultra-low-emission vehicles (SULEVs).

The concept of HEVs is nothing new. Actually, it was patented in 1905 that a battery-powered electric motor was used to boost the acceleration of an ICEV. However, over the years, the development of HEVs had been slow. The major reason was due to their complexity, especially on how to coordinate and combine the mechanical driving forces from both the engine and the electric motor. The turning point of HEV development was the hybrid synergy drive developed for the Toyota Prius in 1997. Subsequently, the development of HEVs has been accelerated dramatically (Chau *et al.*, 2002).

Based on the hybridization level and the operation feature between the engine and the electric motor, HEVs have been further split into the micro hybrid, the mild hybrid and the full hybrid. Recently, this classification has been further extended to include the plug-in hybrid EV (PHEV) and the latest range-extended EV (REEV). Figure 7-2 depicts their classification in terms of the energy source and the propulsion device (Chau, 2010).

For the micro hybrid, the conventional starter motor is eliminated while the conventional generator is replaced by a belt-driven integrated-starter-generator (ISG). This ISG is typically 3–5 kW. Instead of propelling the vehicle, the ISG offers two important hybrid features. One feature is to shut down the engine whenever the vehicle is at rest, so-called the idle stop feature, hence improving the fuel economy for urban driving. Another feature is to recharge the battery primarily during vehicle deceleration or braking, thus offering a mild amount of regenerative braking. The battery voltage is generally 12 V.

For the mild hybrid, the ISG is generally placed between the engine and the transmission. This ISG is typically 7–12 kW. It can provide the hybrid features of idle stop and regenerative braking. Also, the ISG can assist the engine to propel the vehicle, thus allowing for a downsized engine. However, since the engine and the ISG share the same shaft, it can not offer electric launch, namely initial acceleration under electric power only. The battery voltage is typically 36–144 V.

For the full hybrid, the key technology is the electric variable transmission (EVT) system which mainly functions to perform power splitting. This EVT can offer all hybrid features, including the electric launch, the idle stop, the regenerative braking and the engine downsizing. The corresponding electric motor and battery ratings are typically 30–50 kW and 200–500 V,

respectively. Instead of downsizing the engine, the electric motor can be utilized to produce additional torque and hence better acceleration performance than a conventional ICEV with the same size of engine.

offer a long electric-drive range and hence reduce the requirement for refuelling from gas stations. The corresponding electric motor and battery ratings are typically 30–50 kW and 300–500 V, respectively.

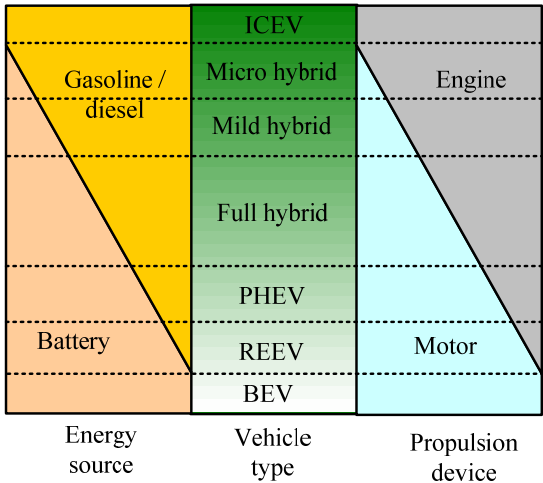

Figure 7-2 Classification of HEVs.

For the PHEV, it provides all features of the full hybrid, while having an additional feature of plug-in rechargeable. Since it incorporates a large bank of batteries which can be recharged by plugging to an external charging port, it can

For the REEV, it provides all features of the plug-in hybrid, but having a small engine coupled with a generator to recharge the battery bank when its capacity is lower than a threshold. This avoids the range anxiety problem that is always associated with the BEV. So, it can offer energy-efficient operation throughout its initial pure-electric range and hence significantly reduce the requirement for refuelling from gas stations. The corresponding electric motor and battery ratings are similar to that of the plug-in hybrid, typically 30–50 kW and 300–500 V.

The use of EVs, no matter the BEV, HEV or FCEV, can enjoy two major benefits. Namely, the energy benefit resulting from better energy diversification and higher energy efficiency, as well as the environmental benefit resulting from better air quality and lower noise pollution.

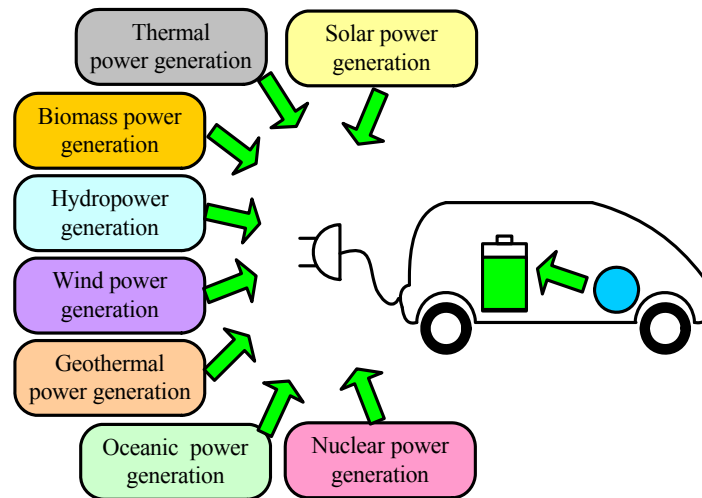

Figure 7-3 Generation of electricity for BEV, PHEV and REEV.

7.2 Energy Benefit

Deriving from oil, gasoline and diesel are the major liquid fuels for ICEVs. Although the development of biofuels has taken on an accelerated pace in recent years, our road vehicles are still heavily dependent on crude oil. EVs are an excellent solution to rectify this unhealthy dependence because electricity can be generated by almost all kinds of energy resources. Figure 7-3 illustrates the merit of

energy diversification for three types of EVs (namely the BEV, PHEV and REEV) in which electricity can be derived from the power grid via thermal power generation, solar power generation, nuclear power generation, hydropower generation, wind power generation, geothermal power generation, oceanic power generation and biomass power generation, as well as from the generator coupled with the engine and the electric motor via regenerative braking.

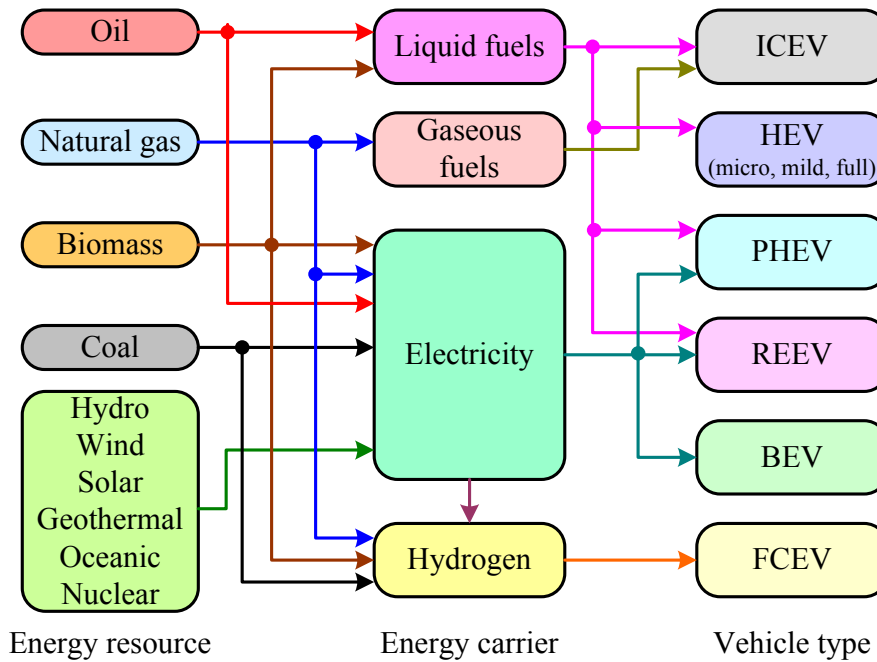

Figure 7-4 Energy conversions for various EVs.

Taking into account various energy resources including the oil (both conventional and non-conventional), the natural gas, the coal, the renewable energies (biomass, hydro, wind, solar, geothermal and oceanic) and the nuclear energy, and various types of EVs including the ICEV, the conventional HEV (micro, mild, full), the PHEV, the REEV, the BEV and the FCEV, the relevant energy conversion processes are depicted in Figure 7-4. It can be found that electricity is the most convenient energy carrier between various energy resources and various

EVs, while liquid fuels including the gasoline, the diesel, the liquefied petroleum gas (LPG) and biofuels are the major energy carrier for the ICEV and various HEVs. Hence, it can be identified that the latest two types of HEVs, namely the PHEV and the REEV, can benefit the greatest energy diversification from accepting both liquid fuels and electricity as their energy carriers.

Besides the definite merit of energy diversification resulting from the use of EVs,

Clean Energy and Environment

another important advantage is the high energy efficiency offered by EVs. In order to compare the overall energy efficiency of the BEV with the ICEV, their energy conversion processes from crude oil to road load are depicted in Figure 7-5, where the numerical data are indicative only. By taking the energy capacity of crude oil as 100%, the overall energy efficiencies for the BEV and ICEV are 18% and 13%, respectively. Therefore, even when all electricity are generated by oil-fired power plants, the BEV is more energy efficient than the ICEV by about 38%. For the HEVs, the corresponding energy efficiencies are between the BEV and ICEV. Typically, they are 20–30% higher energy efficiency or fuel economy than the ICEV. It should be noted that since ICEVs

currently consume over 60% of oil demand in advanced countries, the use of EVs can significantly reduce the consumption of oil, hence saving in both energy and money.

Moreover, all EVs possess one distinct advantage over the ICEV in energy recovery, namely regenerative braking. As shown in Figure 7-6, EVs can recover the kinetic energy during braking or deceleration and utilize it for battery recharging, whereas the ICEV wastefully dissipates this kinetic energy as heat in the brake discs and drums. With this technology, the energy efficiency of EVs can be further boosted by up to 10%.

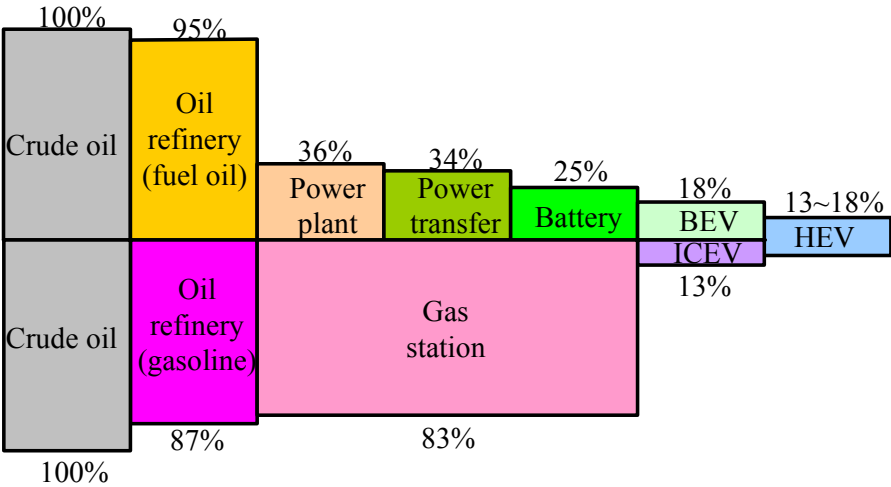

Figure 7-5 Comparison of energy efficiencies between BEV and ICEV.

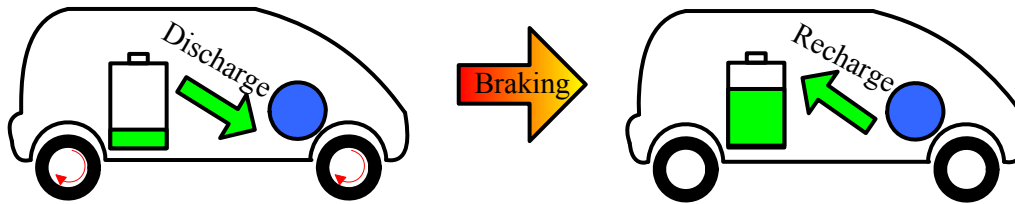

Figure 7-6 Energy recovery by regenerative braking.

7.3 Environmental Benefit

In many metropolises, ICEVs are responsible for over 50% of harmful air pollutants and smog-forming compounds. Although the engine of ICEVs is continually improved to reduce the emitted pollutants, the increase in the number of ICEVs is much faster than the reduction of emissions per vehicle. Thus the total emitted pollutants due to ICEVs, including the carbon monoxide (CO), the hydrocarbons (HC), the nitrogen oxides (NO_x), the sulphur oxides (SO_x), the particulate matter (dust) and the non-methane organic gases (NMOG), continue to grow in worrying trend.

In order to reduce or at least slow down the growth of air pollution due to road transportation, the use of EVs is the most viable choice (Chan *et al.*, 2001). Figure 7-7 shows an indicative comparison of harmful emissions locally generated by the ICEV and the BEV, while those of the HEVs lie between them. As

expected, the BEV offers zero local emissions at all. Taking into account the emissions generated by refineries to produce liquid fuels for the ICEV as well as the emissions by power plants to generate electricity for the BEV, an indicative comparison of global harmful emissions is shown in Figure 7-8. It can be found that the global harmful emissions of the BEV are still much lower than those of the ICEV. For the HEVs, the corresponding global harmful emissions are between the BEV and the ICEV.

Nowadays, many automobile companies produce HEVs, which are not only commercially available but also economically sustainable. The latest flagships include the Chevrolet C15 Silverado Hybrid, the Ford Fusion Hybrid, the Honda Civic Hybrid, the Mercedes Benz S400 Hybrid, the Nissan Altima Hybrid, the Saturn VUE hybrid and the Toyota Prius. In general, they exhibit significant reduction in exhaust emissions as compared with their ICEV counterparts. Nevertheless, different HEV models have different emission

levels of different pollutants. For instance, as listed by the Air Resources Board of the California Environmental Protection Agency in 2009, the Toyota Prius offers a very low level of CO emission while the Mercedes Benz S400 Hybrid provides a very small content of NMOG emission.

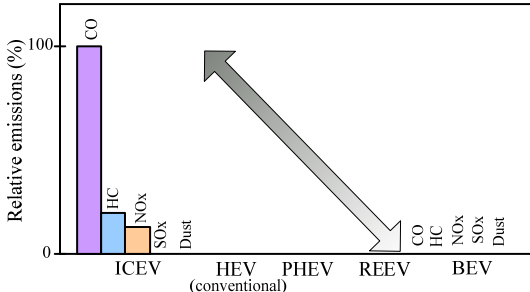

Figure 7-7 Comparison of local harmful emissions.

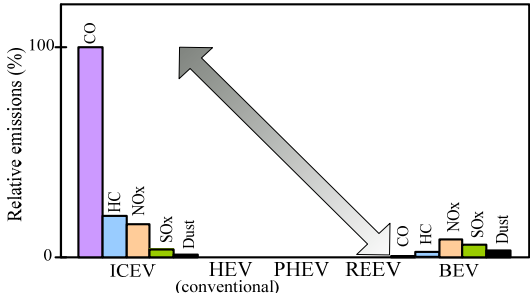

Figure 7-8 Comparison of global harmful emissions.

It should be noted that the global carbon dioxide (CO₂) emission can be reduced by about 5%

with the use of EVs and energy-efficient power plants. This improvement may be further increased with the use of higher percentages of clean or renewable power generation, but may even be negative when adopting inefficient coal-fired power plants.

EVs have another definite advantage over ICEVs on the suppression of noise pollution. Different from the ICEV that its combustion engine and complicated mechanical transmission produce severe noise problems to our surroundings, the BEV is powered by an electric motor operating with very low acoustic noise. Moreover, the BEV offers either gearless or single-speed mechanical transmission so that the corresponding annoying noise is minimal. Figure 7-9 gives an indicative comparison of noise created by the ICEV and the BEV during launching, running, climbing and braking. Of course, the noise of those HEVs lies between them.

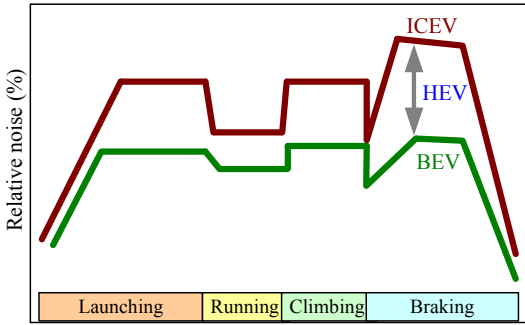

Figure 7-9 Comparison of vehicle noises between BEV and ICEV.

7.4 HKU's Role

The University of Hong Kong (HKU) kicked off the research and development of EVs in the early 1980's. The first EV of Hong Kong, named Mark1, was developed by HKU. This Mark1 was converted from an existing ICEV, namely replacing the engine by the induction motor and adopting lead acid batteries as the energy source. The community became aware of the development of EVs as reflected from the cover page of the HKIE's *Hong Kong Engineer* in December 1984 as shown in Figure 7-10.

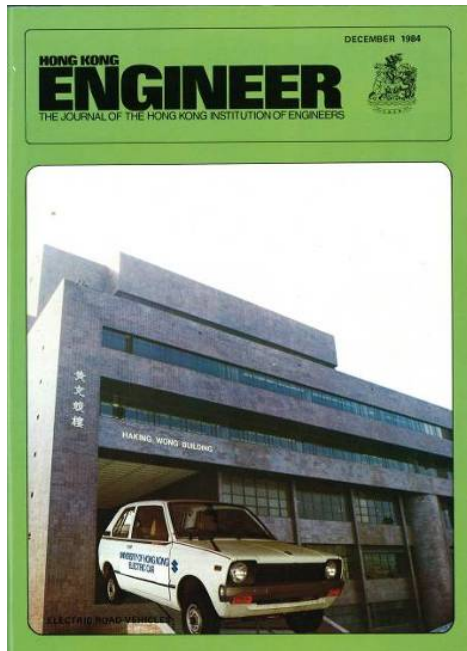

Figure 7-10 Our EV appeared on HKIE's *Hong Kong Engineer* in 1984.

Subsequently, the International Research Centre for Electric Vehicles (IRCEV) was established in HKU in 1986. Its mission is to pursue excellence in research and technology transfer in EV technology. As shown in Figure 7-11, the IRCEV is currently led by Prof. K.T. Chau with the manpower of about 10 researchers and research students.

Over the years, the IRCEV has developed five BEVs as shown in Figure 7-12 in which the Mark1, the Mark2, the Mark3 and the U2001 were based on ICEVs' conversion whereas the eV Light was based on the Reva's ground-up EV. Each EV prototype had its unique features, especially the electric propulsion system. For instance, the Mark1 adopted the variable-voltage variable-frequency (VVVF) induction motor drive, the Mark2 used the vector-controlled induction motor drive, the Mark3 employed the permanent magnet (PM) synchronous motor drive, the U2001 tested our self-developed PM hybrid motor drive and the eV Light tested our self-developed stator-PM brushless motor drive. Also, both the U2001 and the eV Light have installed the variable temperature seats to enhance energy-efficient temperature control.



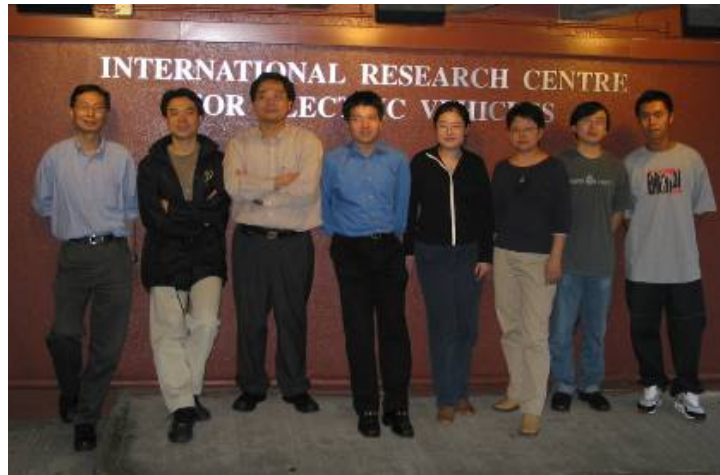

Figure 7-11 Our IRCEV was established in 1986.



Mark I

Clean Energy and Environment



Mark2



Mark3



U2001

Figure 7-12 EV developed in HKU.

Rather than simply promoting EVs using prototypes for demonstration, the IRCEV has made extraordinary contributions to and lasting impact on the field of EV technology:

- (i) Defined the concept of EV drives and identified their performance requirements (Chau *et al.*, 2010).
- (ii) Pioneered the development of AC propulsion systems, especially permanent magnet (PM) brushless motor drives (Chau *et al.*, 2008), for EVs.
- (iii) Developed the class of flux-controllable stator-PM brushless machine drives for EVs, which can offer the advantages of high efficiency, high power density, high controllability and high reliability (Chau, 2009).
- (iv) Educated over 40 PhD/MPhil graduates in the field of EVs serving academia and industries in Hong Kong, mainland and overseas.
- (v) Published over 400 papers in learned journals and conference proceedings in various topics of EV technology.
- (vi) Authored two monographs in the area of EV technology as shown in Figure 7-13. The *Modern Electric Vehicle Technology* (Oxford University Press, 2001) was the first comprehensive monograph in the field of EV technology, which was highly

commended by the Power Engineering Journal – “Their backstage work has been assiduous and careful over the last 20 years. Their comprehensive exposition of the technology will form a handy reference: it has the ring of authority”. The *Advanced EV Drive Technology* in Chinese (China Machine Press, 2010) was a monograph covering research and development of various EV drive systems with emphasis on advanced energy-efficient motor drives and power electronics, which was highly desired by EV researchers and engineers.

- (vii) Wrote two monograph chapters in the area of EV technology as shown in Figure 7-14. The chapter *Electric Motor Drives for Battery, Hybrid and Fuel Cell Vehicles* in *Electric Vehicles: Technology, Research and Development* (Nova Science Publishers, 2009) focused on the latest research and development of electric motor drives for various types of EVs. The chapter *Hybrid Vehicles* in *Alternative Fuels for Transportation* (CRC Press) focused on the research and development of hybrid power trains for different types of HEVs.

Clean Energy and Environment

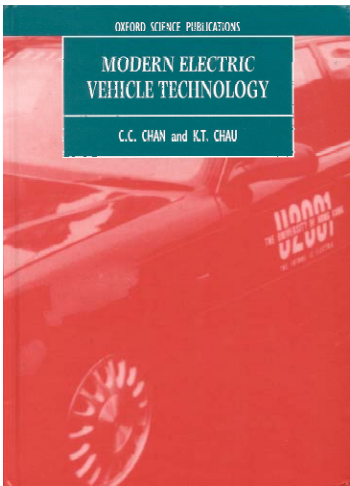

Oxford University Press



China Machine Press

Figure 7-13 Authored books about EVs.

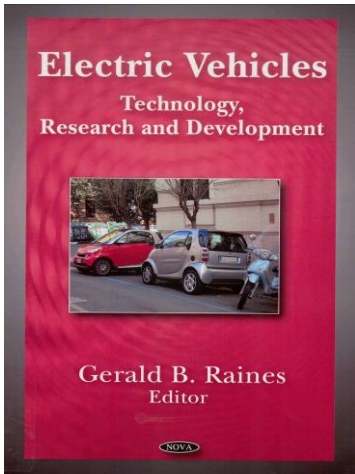

Nova Science Publishers

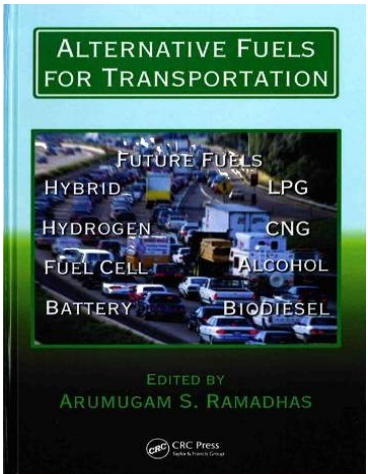

CRC Press

Figure 7-14 Authored books chapters about EVs.

7.5 Research & Development

Currently, many automobile companies throughout the world accelerate the development of EVs for the coming huge market. It is anticipated that the HEVs will be a practical and sustainable solution for the class of super-ultra-low-emission vehicles (SULEVs), while the BEV and the FCEV will share the market of zero-emission vehicles. In view of the fact that the micro hybrid is virtually a motor-assisted ICEV while the REEV is essentially an engine-assisted BEV, the HEVs will be dominant in the automotive market in the near future.

The research and development trends of EVs are twofold: device integration and system crossover. Two emerging device-integration technologies – namely the integration of magnetic gearing and PM brushless motor drives for BEVs or FCEVs, and the integration of PM brushless motor drives and electric variable transmission for HEVs – are elaborated below.

For BEVs and FCEVs, PM brushless motor drives are very attractive since they inherently offer high power density and high efficiency. In particular, in-wheel PM brushless motor drives

can play the role of electronic differential (Chan *et al.*, 2001). As the wheel speed is only about 600 rpm, the in-wheel motor drive is either a low-speed gearless outer-rotor one or a high-speed planetary-gear inner-rotor one. Although the outer-rotor one takes the advantage of gearless operation, its low-speed operation causes bulky size and heavy weight. On the other hand, although the inner-rotor one takes the merits of reduced overall size and weight, the planetary gear inevitably involves transmission loss, acoustic noise and regular lubrication. Recently, magnetic gears are becoming attractive because they inherently offer the merits of high efficiency, reduced acoustic noise and maintenance free. By artfully integrating the magnetic gear into the PM brushless motor drive, the low-speed requirement for direct driving and the high-speed requirement for motor design can be achieved simultaneously (Chau, 2009). Figure 7-15 gives a comparison of the existing planetary-gear inner-rotor topology and the integrative magnetic-gear outer-rotor topology for in-wheel motor drives. This integrative topology not only offers reduced size and weight but also eliminates all drawbacks due to the mechanical gear. The artfulness is the share of the outer rotor of the PM brushless motor and the inner rotor of the magnetic gear.

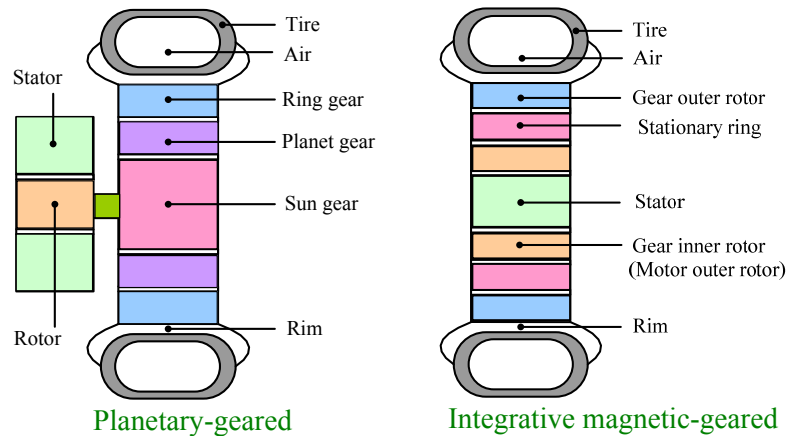
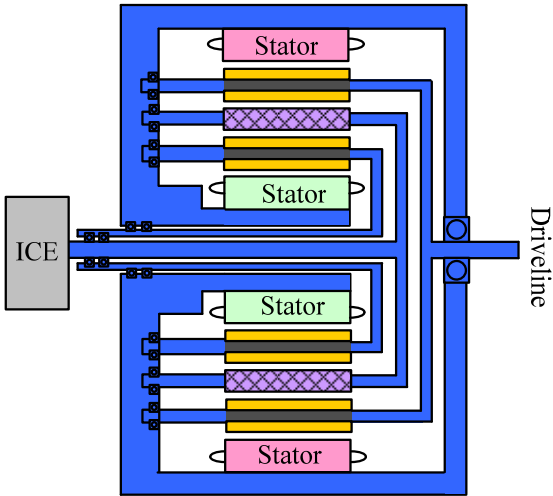
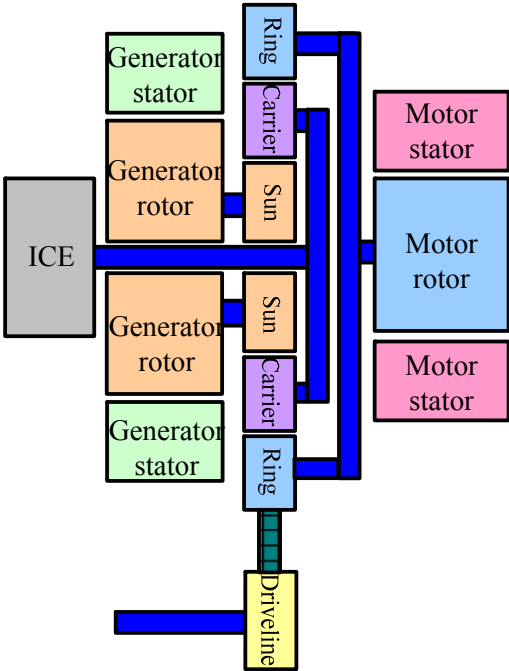

Figure 7-15 Comparison of in-wheel motor drives.

For HEVs, the electric variable transmission (EVT) system functions to perform power splitting of the engine output – one power flow path is mechanically coupled with the motor output and another power flow path is electrically connected with the motor input via power converters (Chau, 2010). Hence, a continuously variable ratio between the engine speed and the wheel speed can be achieved. In the presence of this electronic continuously variable ratio, the engine can always operate at its most energy-efficient operating point, resulting in a considerable reduction of fuel consumption. Figure 7-16 gives a comparison of the existing planetary-geared EVT system which was developed by Toyota for its Prius and the

newly developed magnetic-geared EVT system. Both of them adopt the PM brushless motor drive. The former one inherits the fundamental drawback of planetary gearing, namely the transmission loss, gear noise and need of regular lubrication. On the contrary, the latter one inherits the distinct advantages of magnetic gears, namely non-contact torque transmission and speed variation using the modulation effect of PM fields, hence achieving high transmission efficiency, silent operation and maintenance free. Also, the corresponding mechanical torque transmission is straightforward, simply from the engine at one side to the driveline at another side, without requiring any transmission belts.



Planetary-gear integration

Magnetic-geared integration

Figure 7-16 Comparison of EVT systems.

The vehicle-to-grid (V2G) technology is one of the most emerging system-crossover technologies for EVs. It is a crossover of EVs, power system and information technology. The gridable EV (GEV), which may be a PHEV, REEV or BEV, is no longer a simple transportation means. It can serve as a bidirectional portable power plant for the power grid. Although each GEV can only store or generate a relatively small amount of electrical energy (5-10 kWh for a PHEV, 10-20 kWh for

REEV or 20-50 kWh for a BEV) as compared with the whole power grid, a reasonable penetration rate of GEVs (such as 20-40% vehicles are GEVs) will have a significant impact on power system operation. For instance, the V2G has been identified to have two important functions:

- (1) Since renewable power generations, such as wind power and solar power, are intermittent in nature, the use of standby generators to backup

the intermittent power outage is expensive, inefficient and sluggish. Although the use of a battery energy storage system (BESS) can perform the desired efficient and fast backup, this BESS is too expensive and bulky. The V2G technology can fully utilize the batteries installed in GEVs. Namely, when GEVs are parking at their lots, they can provide or sell instantaneous power to the grid so as to backup the intermittent power outage while avoiding the installation of the BESS.

(2) Since the power generation capacity has to match with the load demand, a large fluctuation of load demand will significantly increase the capital cost and operating cost of the power system.

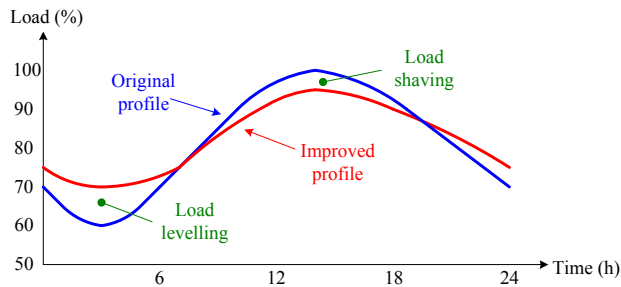

Figure 7-17 Load levelling and load shaving.

As shown in Figure 7-17, the V2G technology can utilize the batteries in GEVs to absorb or buy electrical energy from the grid during the

off-peak period (called load levelling), whereas to generate or sell electrical energy to the grid during peak period (called load shaving). Also, the corresponding charging and discharging processes are much faster than the shutoff and startup processes of standby generators.

The key to achieve the aforementioned two functions is the V2G framework. The latest aggregated dual-grid framework is depicted in Figure 7-18 in which the ESP is the energy service provider that markets and sells power directly to homes and businesses, the ISO is the independent system operator that oversees the operations of a particular section of the power grid, the RTO is the regional transmission organization that integrates the ISOs into larger operations, and the aggregator functions to aggregate the GEVs to deal with the ESP and the ISO/RTO. Firstly, the aggregator coordinates the intragrid power flow, minimizes the total power demand and total power loss, optimizes the voltage deviation and total harmonic distortion, and calculates prices to maximize the profit of intragrid operation. Secondly, the aggregator coordinates the intergrid power flow, deals with the ISO/RTO to sell power and energy, deals with the ESP to buy power and energy, and calculates prices to maximize the profit of intergrid operation.

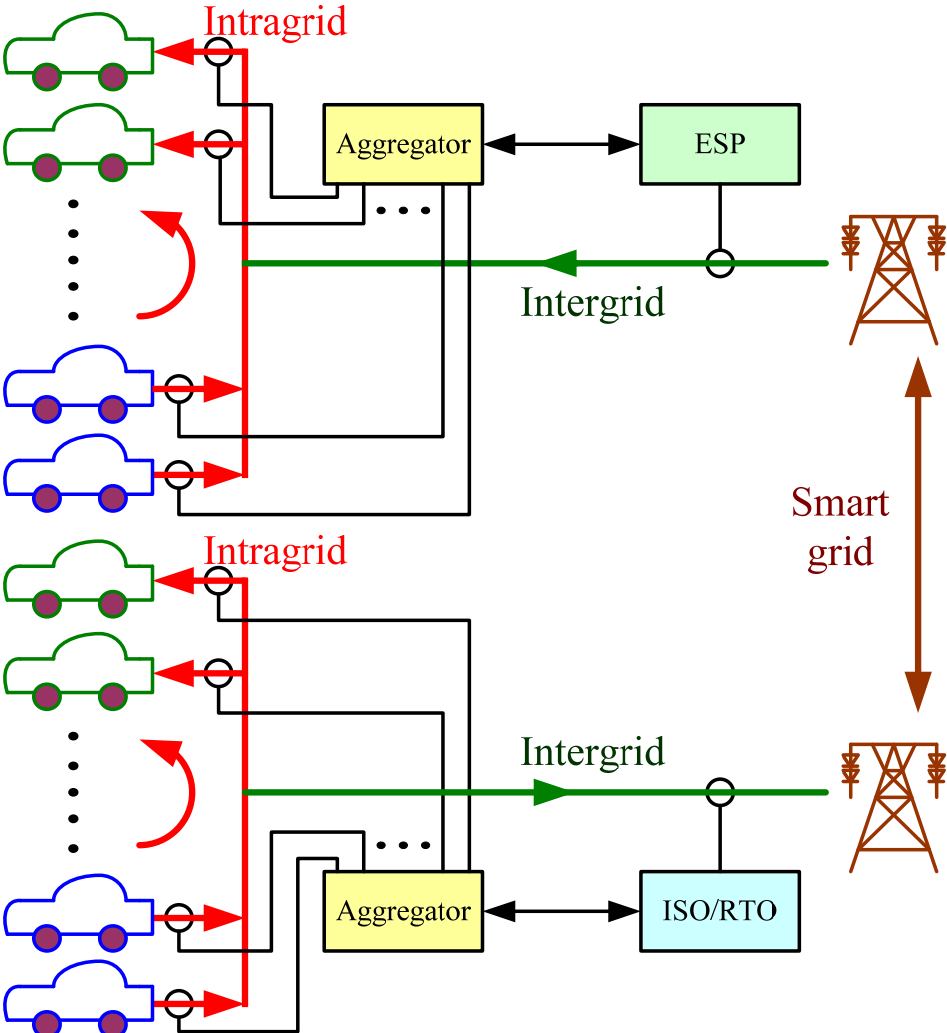

Figure 7-18 Aggregated dual-grid V2G framework

7.6 Vision

Among all types of EVs, the PHEV will be popular in the next five years, whereas the FCEV will not be popular in the next five years unless there is a breakthrough in fuel cell technology. Most vehicles will be sorts of EVs, at least micro hybrid, and the BEV, HEV and FCEV will coexist in future. The V2G energy arbitrage will be the key to further boost the research and development of EVs.

Acknowledgement

The author would like to express heartfelt thank to all group members of the IRCEV for their contributions to the field of EV technology and this chapter. He must express his indebtedness to Joan and Aten for their support all the way.

References

1. Chan, C.C., and K.T. Chau. 2001. *Modern Electric Vehicle Technology*. UK: Oxford University Press.
2. Chau, K.T. 2009. *Electric Motor Drives for Battery, Hybrid and Fuel Cell Vehicles*. In *Electric Vehicles: Technology, Research and Development*, ed. G.B. Raines. Nova Science Publishers.
3. Chau, K.T. 2010. *Hybrid Vehicles*. In *Alternative Fuels for Transportation*, ed. A.S. Ramadhas. CRC Press / Taylors and Francis Group.
4. Chau, K.T., and C.C. Chan. 2007. Emerging energy-efficient technologies for hybrid electric vehicles. *Proceedings of IEEE* 95:821-835.
5. Chau, K.T., and M. Cheng. 2010. *电动汽车的新型驱动技术*. 北京: 机械工业出版社.
6. Chau, K.T., and Y.S. Wong. 2002. Overview of power management in hybrid electric vehicles. *Energy Conversion and Management* 43:1953-1968.
7. Chau, K.T., C.C. Chan, and C. Liu 2008. Overview of permanent-magnet brushless drives for electric and hybrid electric vehicles. *IEEE Transactions on Industrial Electronics* 55:2246-2257.
8. Chau, K.T., Y.S. Wong, and C.C. Chan. 1999. An overview of energy sources for electric vehicles. *Energy Conversion and Management* 40:1021-1039.

The background of the slide is a photograph of a server rack. The server units are silver with a perforated front panel. Each unit has a blue indicator light and a label that reads "PowerEdge 1950". A white text box with a blue border is overlaid on the right side of the image, containing the title and main text.

Carbon Reduction by Green ICT

In addition to faculties from the University of Hong Kong, many alumni are also proactively contributing to resolve the environmental issues. Under the supervision of Dr. Lawrence Cheung at Hong Kong Productivity Council, Dr. Victor Ng, the Honorary Lecture of the Department of Electrical and Electronic Engineering of the University of Hong Kong, and other members of the team at the Hong Kong Productivity Council, are actively promoting and participating in green ICT initiatives. This chapter offers a brief overview of the technologies and practices that come under the Green ICT initiatives.

* Please reboot the server if IIS not start & manual start the Foxweb when startup

PowerEdge
1950

8 Green Information Communication Technology

Lawrence Cheung¹, Hon Ng^{1,2}, Clifford Loo¹

¹Hong Kong Productivity Council

²Honorary Lecturer, Department of Electrical and Electronic Engineering, HKU

8.1 Introduction of Green ICT

The colour green has become synonymous with caring for our planet, living in harmony with nature and all its creatures and resources. To us practical city dwellers, besides environmental friendliness, the word “green” has come to stand for high efficiency, social responsibility and a lifestyle of clean living. It is a higher goal to aim for than mere economic prosperity, and is embraced the world over by a growing number who are setting their sight beyond material affluence.

The term “Information and Communication Technologies” (ICT) is a conflation of IT and the more traditional telecommunication technologies. Developments in recent years of the internet, mobile communication technologies and broadband infrastructures have increasingly blurred the line between telecommunication (telephony) and data networking (internet). Many service providers are, in fact, wearing multiple hats, as internet

service provider (ISP), Wi-Fi operator, mobile network operator (MNO), and/or local fixed network (telephone service) operator; many hybrid network service packages are on offer as a result. As to consumer products, virtually any mobile phone now hitting the market is a potential internet access terminal, requiring only a mobile data service plan, much as a personal computer (PC) requiring an ISP or Wi-Fi service plan. Many notebook computers are now connecting to the internet through both the cellular and Wi-Fi networks, whichever is available or more cost effective, through a finger-size USB network adaptor. The age of convergence is finally upon us.

Unique opportunities are presented to the ICT sector in a carbon-constrained world. In recent years, the movement of “Green ICT” has been developed quickly overseas, which aims to research on environmental impact of ICT and to carry out projects on the use of ICT applications for sustainable development. Worldwide, Green ICT is regarded as key to reducing energy

consumption and carbon emission, particularly in Europe and in China. [1]

8.2 Green ICT through the two approaches and seven perspectives

One of our missions is to offer professional advices to our clients to implement green ICT in their organization. There two approaches in our advices:

- i) First approach: Green by ICT – how to reduce our burden on the natural environment through the use of ICT; and
- ii) Second approach: Make ICT Green – how to reduce the environmental impact of ICT itself.

There are three perspectives for the first approach: Green by ICT, they are;

- (i) Dematerialization and waste reduction
- (ii) Energy management (smart buildings, smart grids)
- (iii) Process/flow control (ICT solutions for more efficient manufacturing, logistics, transportation, etc.)

There are four perspectives for the second approach: Make ICT Green, they are;

- (i) Virtualization
- (ii) ICT Facilities energy optimization
- (iii) Eco-friendly equipment procurement

- (iv) Environment conscious disposal (reuse, recycle)

Some tips for green ICT implementation are listed in the following sections.

8.2.1 Dematerialization and Waste Reduction

E-mail has long since replaced hand-delivered mail (or Snail mail, as some would call it) for informal and even short formal correspondence. Users of webmail services have already exceeded 600 million back in 2008. [2].

	million users
Microsoft webmail	256.2
Yahoo	254.6
Google	91.6
AOL webmail	48.9

Table 8-1 Figures of web-mail uses as at February 2008
(Source: USA Today article, April 2008)

The transmission and perusal of documents—from the learned, technical, merely informative to the entirely frivolous, pure entertainment, bank statements, payslips, newspapers, magazines and even music scores—have also gone down the road to dematerialization by “electronification.” All this helps to cut back on our reliance on and consumption of paper as a communication medium, both at home, school and in the office.

Clean Energy and Environment



Figure 8-1 No more paper lecture notes!
HKU Students uses smart phones and tablet
computers to conduct interactive class.

Traditionally an energy management system (EMS) comprises a collection of computer-aided tools for operators of electric utility grids to monitor, control, and optimize the performance

of the generation and/or transmission systems. The monitor and control functions are known as SCADA (supervisory control and data acquisition), which generally refers to computer systems that monitor and control industrial, infrastructure, or facility-based processes. The optimization packages are often referred to as "advanced applications".

The computer technology is sometimes known as SCADA/EMS or EMS/SCADA, and in this terminology EMS then excludes the monitoring and control functions, but more specifically refers to the collective suite of power network applications and to the generation control and scheduling applications. Harris Controls (now GE), Hitachi, Cebyc, Siemens, Toshiba, Digital Equipment, Gould Electronics and MODCOMP were early players in this market supplying proprietary solutions. Later on EMS suppliers began to deliver solutions based on industry standard hardware platforms such as those from HP, IBM and Sun, running UNIX-, Linux-, or Windows-based systems.

In another context, EMS can also refer to a computer system designed specifically for the automated control and monitoring of the heating, ventilation and lighting needs of a building or group of buildings such as university campuses, office buildings or factories. Most of these energy management systems also provide facilities for the reading of electricity, gas and water meters. The data obtained from these can then be used to produce trend analysis and annual consumption forecasts.

8.2.2 Process/Flow Control

Besides its use for SCADA (see above) in industrial control systems, ICT also makes a contribution to environmental sustainability on a user level in terms of process and flow control. Enterprise users could take advantage of process automation in order to reduce their environmental impacts. For example, businesses in the service sector such as wholesale and retail, logistics and transportation: by establishing a B2B (business-to-business) e-commerce service platform to improve the business efficiency with the supply chain, by promoting a B2C (business-to-consumer) interface to serve the general public through a more energy-saving way.

Green ICT as applied to process and flow control is a practice and an application area based on mature technologies, including computer software, electronic sensors, monitoring and control devices, machine-to-machine (M2M) communications, wireless and mobile technologies. The recent uptake of wireless and wired network data utilization has greatly driven down the costs, providing an environment more amenable than ever to the deployment of automated flow control systems.

In the manufacturing and distribution industries, operational efficiency often hinges on assigning the best resources to each task, at the best possible time. Examples include identifying the optimized production scheduling, shop floor design, inventory planning, bag/container

packing, distribution network, manpower assignment, and so on. Due to the complex nature of such problems, modern computers and IT tools are now increasingly indispensable in the decision making process, and the factory deployment of wireless monitoring devices helps identify inefficiency and control energy consumption through M2M technologies.

In the transportation sector, Fleet Management System (FMS) is a term that broadly includes a range of vehicle-related IT solutions, which help logistics and trucking companies to improve operational efficiency. Typical functions of a FMS include vehicle tracking by satellite positioning, job dispatch through mobile communication, optimal routing by incorporating up-to-date geographic maps and traffic information, and vehicle maintenance by analyzing the distance travelled, gas usage, brake status, etc.

A significant proportion of carbon emission can be attributed to transportation. According to a survey published by the HKSAR government ^[1], the transportation sector accounts for 35% of Hong Kong's total end-use energy consumption. In the US and Europe, one-fifth and one-third of CO₂ emission are also due to transportation ^{[2][3]}. Therefore, by improving the cost efficiency of vehicle fleets under management, FMS can be an important part of any regional green initiative.

8.2.3 Virtualization

Computer equipment virtualization is the execution of software in an environment separate from the actual underlying hardware resources. The concepts of virtualization have found their natural evolution and blossoming in Cloud Computing, the latest trend in enterprise IT. Much like public utilities such as water, electricity, and gas, computer resources are provisioned from the “cloud” (the internet) through network connections and charged by the amount of use. Cloud computing offers immense flexibility and scalability, at a low cost of ownership. If the user needs to use more, or less, of a particular service, the computer resources can easily and quickly be re-configured to accommodate the change. Although the usual goal of virtualization is to centralize administrative tasks while improving scalability and work loads, the technology also promotes highly efficient energy consumption and hardware use by pooling resources together, from which to create independent virtual instances of them. Software applications running on virtual hardware are actually sharing the same pieces of physical equipment, with the virtualization platform balancing workloads between virtual instances for optimal utilization.

By aggregating computer resources in cloud compute server farms (data centres), higher resource utilization and therefore higher energy efficiency can be achieved through centralized management. This can also result in lower environmental impact, by moving infrastructure

and server farms to locations with lower population density and lower temperature, reducing ventilation requirements and carbon emission.

On the high end of the office portability scale, mobile and cloud ICT solutions have enhanced productivity by enabling the many SMEs to conduct business on the road during frequent travels. As more and more portable devices and smartphones begin to rival full-fledged PCs in sophistication and power, and as more and more actual computing is done “in the cloud” rather than on the desktop, businessmen are feeling more secure travelling with just a pocket device or a tablet. This shrinking of the user terminal device also results in shrinkage in the corresponding carbon footprint, as component miniaturization results in a corresponding reduction in energy consumption.

8.2.4 ICT Facilities Energy Optimization

Significant carbon reduction can be achieved from energy conservation at ICT facilities such as data processing centres, network operation centres, internet exchange points, IT server rooms, printer centres, etc. Over the past decade, reliability has been prioritized almost to the exclusion of any other issue, including energy efficiency. According to the 1E Server Energy and Efficiency Report 2009, a joint independent research with the Alliance to Save Energy (US) regarding the awareness and behaviour of server

Clean Energy and Environment

administrators in the world's largest companies, "at least 4.7 million servers (more than 10% of the total number of servers worldwide) needlessly cost IT departments over 4,000 (US) dollars per server per year in operational costs."



Figure 8-2 More processors packed into servers rises the server power density by 10

Data centres consume a staggering amount of energy. A typical 20,000-square-foot enterprise data centre at 100 watts per square foot has a peak cooling demand that is comparable to a 200,000-square-foot commercial office building, and total annual energy consumption comparable to that of a 400,000-square-foot commercial office building. This intense energy requirement is due largely to increasing server density. Manufacturers are packing more processors and more computing power into every server; server density has increased tenfold over the past decade[3], and the average server's power consumption has quadrupled. Higher density results in higher operating temperatures, and greater power and cooling requirements to prevent systems failure.

While they consume far more than their share of electricity, data Centres also have far more potential for improvement than other energy-intensive building sites such as healthcare facilities or commercial buildings. On a square-foot basis, a data centre will cost 4 to 5 times as much to construct as a commercial office building, but annual electricity costs will be 25 to 30 times as much. As a percentage of first costs, introducing energy reduction alternatives in a data centre will deliver much stronger economic benefits than introducing the same alternatives in a commercial office building.



Figure 8-3 Variable-speed CRAC can save up to 40% of fan power consumption.

The EPA estimates that energy-management best practices combined with IT consolidation could reduce data centre power consumption by as much as 45 percent[4]. Here are just some of the small changes that can yield big returns in the energy efficiency of a data centre:

- (i) Employing lighting controls such as occupancy sensors in data centre halls, emergency generator(s), uninterruptible power supply(ies) (UPSs), battery rooms, and other back-of-house areas. This can reduce total lighting energy consumption by 25% to 50% per year.
- (ii) Employing energy-efficient lighting that uses electronic ballast and T-5 lamps. This can reduce total lighting energy consumption by 10% to 15% per year—and much more, if LED lighting is used.

Clean Energy and Environment

- (iii) Switching to variable-speed motors for HVAC equipment such as computer and data processing room (CDPR) unitary air conditioners, pumps, and cooling tower fans.
 - (iv) A fan running at 80% speed will consume only 50% of the power at full speed; at 50% fan speed, only 13% power.
 - (v) On average, variable-speed computer room air conditioning (CRAC) / computer room air handling (CRAH) fans can yield potential savings of up to 40% of fan power consumption.
 - (vi) Using a variable-speed chiller in a new application or as a replacement for fixed-speed chillers will reduce chiller energy consumption by over 35%. In a new data centre, the payback time for this would be less than a year.
 - (vii) Raising the chilled water temperature set point to 48°F (0.83°C). For every one degree Fahrenheit (0.55 degree Celsius) of chilled water supply temperature increase, there is a potential 3.5% chiller power savings for chillers with variable-frequency drives (VFDs) and 1% to 1.5% savings for fixed-speed chillers.
 - (viii) Adjusting server rows to eliminate spaces between racks. Spaces between racks increase recirculation from the exhaust to the servers' intake, resulting in hot spots. The equipment will work more efficiently stacked side to side with no space in between.
 - (ix) Considering an efficient layout such as cold aisle / hot aisle arrangement. Hot/Cold aisle arrangement combined with suitable CRAH/CRAC locations can save 5% to 12% of power consumption.
 - (x) Removing/reducing the number of low-voltage (LV) transformers downstream from UPS system(s). Standard LV transformer energy losses (heat rejection) are 1% to 2% of its size.
 - (xi) Avoiding power distribution units (PDUs) with built-in transformers. By moving LV transformers (or PDUs) outside the raised floor area without air conditioning, the total energy losses in a 10,000-square-foot data centre can be reduced by 14 tons.
- Energy optimization practices can sometimes be extended to a general office setting, too. Some energy conservation can be achieved by simply changing users' behaviour, such as enabling hibernation/standby mode for idle periods and switching off computers after work; additional energy saving can come from using eco-cooling systems (e.g. evaporative coolers) instead of only relying on air-conditioning.

8.2.5 Eco-friendly Equipment Procurement

To encourage the production and use of energy-efficient, environment-friendly products, companies could recommend procurement criteria to ensure that procurement guidelines are useful, fair, understandable, and

Clean Energy and Environment

environmentally and economically viable for suppliers.

The regulatory or voluntary requirements affecting IT organizations and their suppliers cover many attributes. The environmentally responsible company could define product attributes for its procurement of PCs (desktop & notebook computers) and monitors, servers, imaging & printing devices and printing supplies to meet higher requirements. Also, generic attributes on product packaging, end-of-use services, supply chain responsibility and organization's performance could also be established to facilitate green procurement. Preference could be given to the use of environmental standards, self-declarations and eco-labels.

Leaders in green ICT practices would disclose a list of key suppliers and adopt the Electronics Industry Code of Conduct (EICC). The Code outlines standards to ensure that working conditions in the electronics industry supply chain are safe, that workers are treated with respect and dignity, and that manufacturing processes are environmentally responsible. They would also report carbon emissions data not just for their own operations, but also for those of their largest suppliers.

8.2.6 Environment Conscious Disposal

As the cornerstone of most waste minimization strategies, the five-step waste hierarchy consists of: reduce, reuse, recycle, recover and dispose.

The aim is to extract the maximum practical benefits from products and to generate the minimum amount of waste.



Figure 8-4 Reduce, reuse, recycle, recover and dispose are the five strategies for waste minimization

Before an ICT product is put to waste, there is much that can be done to maximize its usefulness and minimize its harm to the environment. There are manufacturers who offer clients ICT products that have been discontinued and no longer manufactured as new. Remanufactured products come from various sources, including customer returns and cancelled orders, demonstration and trial units, overstocks, products damaged during shipping, and lease returns. These products are inspected, refurbished or remanufactured, and re-boxed to offer a low cost solution with a limited warranty.

Clean Energy and Environment

And when an ICT product has come to the end of its useful life, there are recycling standards to ensure the hardware and its electronic wastes are responsibly recycled. In Hong Kong, hardware recycling services are available from individual vendors for end-of-life computing equipment like personal computer, laptop, computer monitor, handheld, notebook, server, printers, scanners, fax machine, digital camera, as well as associated external components such as cable, mouse and keyboards. The Hong Kong Computer Recycling Program, with support from the Hong Kong Government, was set up to take back unwanted IT equipment for recycling in an environmental sound manner. Collection is done in various housing estates in Hong Kong periodically. After the collection, equipment is transported to an approved electronic recycler, dismantled into different materials and component parts, and sent off to further processing.

Accessories of ICT products, such as rechargeable batteries and printer cartridges, are also well taken care of. A rechargeable battery recycling programme is run by the Environmental Protection Department, Friends of the Earth and Green Power, providing collection service for more than 830 housing estates, 190 commercial/industrial buildings and 160 schools while 650 public collection points are located in convenient locations such as MTR stations, electronic equipment shops and convenience stores. Various printer makers are offering free return and recycling programmes

in Hong Kong for laserjet and inkjet print cartridges. Customers can easily return cartridges for recycling in a socially and environmentally responsible manner through such programmes. One vendor has even joined forces with Hong Kong Post to provide a free collection service and convenient drop-off points to encourage recycling. Users can deposit used print cartridges in the recycling bin at 10 Hong Kong Post outlets.

8.3 Knowledge exchange on Green ICT

To promote knowledge exchange on Green ICT with industry practitioners, we also partnered with academia and professional bodies to organize training courses related to this area. In May 2010, a training course on “Green ICT and Logistics” was conducted. Experts from the University of Hong Kong, Hong Kong Institution of Engineers, industry and government were invited to share their knowledge and experience to educate practitioners on concepts and applications of Green ICT technologies and practices. We aimed to arouse public awareness on Green ICT and hence to promote further adoption in this area.

8.4 Conclusion

Increasing pressures on the world—population growth, economic development, climate change, etc.—have made us see environmental responsibility as a business issue. As customers, stakeholders, and analysts increasingly expect companies to consider sustainability and to act

upon it, ICT is playing a bigger role than ever both as an enabling agent and as an important part of the issue. In this chapter we have briefly describe some of the ways in which we can reduce our burden on the natural environment through the use of ICT (Green by ICT) and how we can reduce the environmental impact of ICT itself (Make ICT Green). With the foreseeable technological advancement and our increasing reliance upon ICT in the near future, Green ICT will be a key topic in any political or environmental agenda.

Reference

- [1] Carbon Connections: Quantifying mobile's role in tackling climate change, Accenture/Vodafone, July 2009.
- [2] USA Today article, April 2008
- [3] "Datacom Equipment and Power Trends and Cooling Applications," American Society for Heating, Refrigeration, and Air-Conditioning Engineers, 2005.
- [4] "Report to Congress on Server and Data Center Energy Efficiency," U.S. Environmental Protection Agency, August 2007.

9 Magnetism in clean energy and environment

Kelvin T. H. Hui, L. F. Cheung, K. S. Lui, Philip W. T. Pong
Department of Electrical and Electronic Engineering, The University of Hong Kong

9.1 Introduction

Implementation of modern clean energy technology was crippled by its inefficiency, yet magnetism might be the answer to the problem. First, power generation involving turbines and energy storage systems infused with flywheel technology has many limitations, namely frictional loss, speed limit, etc. By introducing superconductor bearings, it is possible to dramatically reduce frictional loss by magnetic levitation. Second, coolants used in traditional refrigeration has been causing extensive environmental problem. Such problem can be solved by using magnetic refrigeration which does not require traditional coolants at all. Third, magnetism may also be the key to overcome technical barriers in nuclear fusion. The difficulty of harnessing fusion power is to provide a stable and extremely hot environment for fusion to take place. This can be achieved by magnetic levitation and confinement. This chapter will provide a complete walkthrough on how all these solutions are possible.

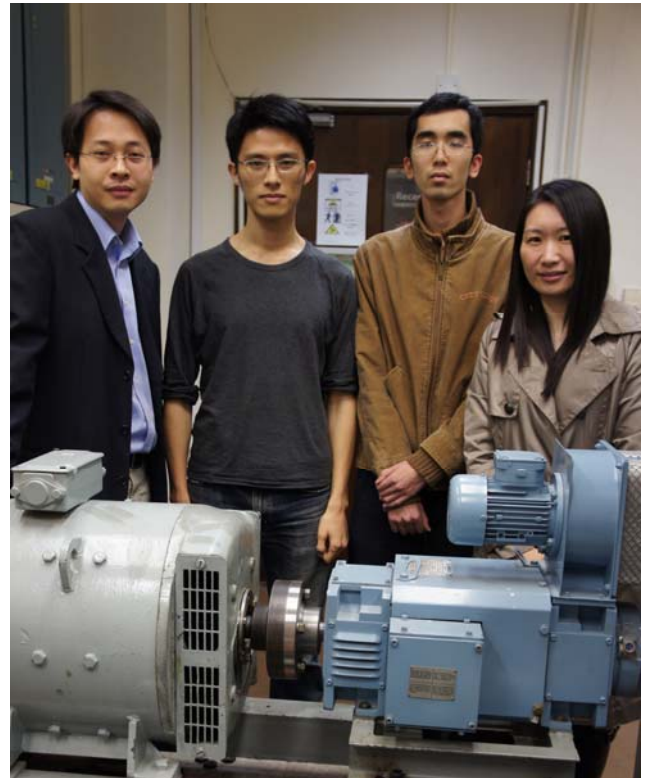

Figure 9-1 Philip W. T. Pong, Kelvin T. H. Hui, L. F. Cheung, K. S. Lui and an electrical machine

9.2 Magnetism in clean energy generation – a case study wind energy

9.2.1 Structure of wind Turbine

Wind turbines (Figure 9-2) are commonly used in clean energy. A wind turbine consists of three components, namely support, rotor, and generator. Support components provide mechanical support for wind turbines. The rotor components consist of rotors and blades that are responsible for converting wind energy to rotational energy. The generator components consisting of an electrical generator and a gearbox are responsible for converting rotational energy to electrical energy. Wind turbines are clean because they do not produce any carbon pollutants during the energy generation process.



Figure 9-2 Wind turbines

9.2.2 Energy storage system: flywheel

Since wind speeds are not constant, flywheel systems are often used to store the wind energy. A flywheel system (Figure 9-3) functions by accelerating the rotor to a high speed to store the energy as rotational energy. By conservation of energy, energy can be later extracted from the system by converting rotational energy back into electrical energy. It has several advantages over other energy storage systems. First, it is easy to store energy comparing to chemical batteries. Second, it has a relatively long life-time [1]. Lastly, it does not impose any environmental disposal problems such as chemical wastes as in chemical batteries.



Figure 9-3 Flywheel system

9.2.3 Frictional loss and limitation of existing bearing system

In conventional rotor systems, bearings are in contact with the rotor shafts. In other words, there is always friction between the contact surfaces. This limits the rotational speed of turbines and flywheels. If the rotational speed exceeds the speed limit of bearings, it will cause significant energy loss and damage to the mechanical components. A better alternative is to use magnetic bearings.

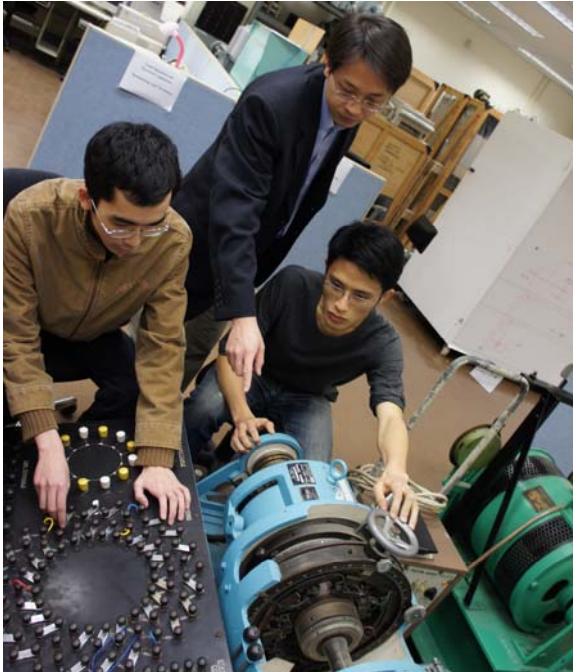

Figure 9-4 Energy efficiency of electrical machines can be improved by magnetism

9.2.4 Magnetic bearing

Mechanism of magnetic bearings

Traditional bearings (Figure 9-5) suffer the friction at the mechanical contact between two surfaces. Magnetic bearings can alleviate this problem, and they support the load by magnetic levitation. They make use of mutual magnetic repulsion between the bearings and loads to establish levitation of the loads. This greatly reduces the mechanical contact between two surfaces and thus minimizes the friction. This increases the speed limit and extends the service lifetime of the bearings.



Figure 9-5 The performance of traditional bearings is constrained by friction

Limitations of magnetic bearings

However, there are some drawbacks on magnetic bearings. Magnetic bearings need sensors, amplifiers, and controllers to control magnetic field strength to regulate the system. This increases the cost and the complexity of the

system design. On the other hand, compared to normal bearings with the same load, magnetic bearings are larger and more difficult to install.

9.2.5 Superconductor bearings

How it works

Superconductors give perfect diamagnetic effect which can produce effective magnetic levitation. Diamagnetic effect refers to the phenomenon where an opposite magnetic field is induced in a material by an externally applied magnetic field. In Figure 9-6, we can see that there are no field lines penetrating through the superconductor. Instead, the field lines are diverted around the superconductor. Therefore, the superconductor bearings do not require external power supply and the bearings are suspended passively because the suspension is not caused by mutual repulsion.

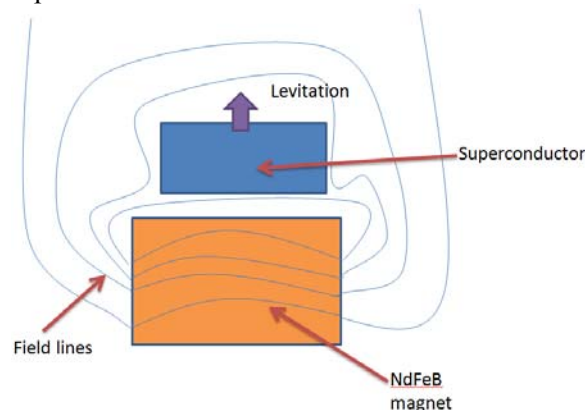

Figure 9-6 Behavior of a superconductor under the influence of magnetic field.

Advantages over magnetic bearing systems

The passive magnetic levitation does not rely on any control systems. Size and complexity of the bearing systems can then be greatly reduced. Unlike coil driven magnetic bearings, it does not need energy to sustain suspension. Thus it is comparatively more energy efficient than magnetic bearing systems.

Obstacles and vision

However, superconducting bearings must operate at a very low temperature (below around 100 K) to achieve superconductivity. This is a big technical barrier to overcome for practical applications. The low-temperature environment can be created by using liquid nitrogen or liquid helium. This has been applied to small-scale superconductor flywheel systems but not large-scale clean energy generators like wind turbines. Apart from cooling methods, researchers are looking for superconductors which can operate at higher temperatures.

9.3 Magnetism in fusion power

Fusion power is regarded as clean energy because it does not produce carbon emission or radioactive by-products. Deuterium, a stable hydrogen isotope with a natural abundance in ocean, is commonly used as fuel source in nuclear fusion. In fusion, two atomic nuclei are combined into a heavier nucleus. The

combination of two nuclei will release heat that can be used to generate electricity.

9.3.1 Current problem in nuclear fusion

In order to make two positively charged light atomic nuclei fuse together, we can make use of the ionization of plasma. In plasma state, charged particles, positive ions, and negative electrons inside an atom will be dissociated. This can help nuclear fusion to ignite. However, a stable and very high-temperature environment with high-density plasma (~100 million degree Celsius) has to be sustained. Levitated dipole experiment (LDX) is therefore carried out to overcome this technical challenge.

9.3.2 Levitated dipole experiment (LDX)

Levitated dipole experiment can provide a solution by applying magnetic suspension and confinement. The levitating dipole reactor used in the experiment consists of a giant torus-shaped magnet suspended by electromagnetic field [2]. This provides effective separation of heat transfer. Moreover, the LDX takes a new approach of magnetic confinement. Magnetic field is used to confine the hot plasma such that the plasma condenses inside the magnet (turbulent pinching) instead of spreading out [3][4]. As such, high-density plasma can be obtained which is critical for starting the fusion.

9.4 Magnetism in refrigerating technology

9.4.1 Current problem in refrigeration

Common household refrigerating systems in air-conditioning and refrigerators use vapor-compression as a refrigerating mechanism. The vapor-compression uses coolants as a medium which are used to remove heat in the refrigerating systems. Therefore, coolants are required. Chlorofluorocarbons (CFCs) were widely used as coolants but they are now banned because their leakages to the atmosphere are causing ozone depletion. CFCs perform catalytic free-radical reactions [5] in the ozone layer which is a layer filtering most of the UV light from the sun. In the presence of UV light, CFCs produce chlorine radicals and react with ozone to form reactive ClO^\cdot (hypochlorite or Chlorate (I)) compounds. This causes continuous loss of ozone layer and creates ozone holes in which UV light can reach the Earth surface directly without natural filtering [6]. The existence of ozone holes increases the potential hazard of skin cancers [7] and cortical cataracts [8]. Most of the refrigerators nowadays use alternative coolants like hydrofluorocarbons (HFCs) which are less reactive than CFCs. However, HFCs are flammable and extra monitoring costs are needed for refrigeration [9].

9.4.2 Magnetic refrigeration

Magnetic refrigerating system can be one of the clean alternatives. Magnetic refrigeration is

based on the principle of the magnetocaloric effect (MCE) which does not require any traditional coolants or flammable materials. The magnetocaloric effect was discovered in iron sample by Warburg and its sophisticated mechanism was later explained by Debye and Giauque independently [10]. Currently, MCE is not applicable in domestic use yet. One of the reasons is because large MCE can only be achieved by pumping helium vapors below 0.3 K. Fortunately, the discovery of giant MCE in some alloys like gadolinium alloy $Gd_5Si_2Ge_2$ in 1997 by Pecharsky and Gschneidner makes MCE an emerging technology in magnetic refrigeration. [10][11][12].

9.4.3 Mechanism of magnetic refrigeration

The mechanism of magnetic refrigeration is illustrated in Figure 9-7. First, the magnetic dipoles inside the MCE material are disoriented. After magnetization, the magnetic dipoles become orientated and the disorderliness of the material reduces. According to thermodynamics, the reorientation decreases disorderliness resulting in decreases in entropy and heat capacity. In other words, the material releases heat and becomes cooled. After that, the

material undergoes demagnetization. This causes disorientation of the magnetic dipoles and increases disorderliness of the dipoles. The material then absorbs heat from surrounding. This reduces the surrounding temperature and causes refrigerating effect. This cycle is repeated to sustain the refrigerating function.

9.4.4 Advantages over current vapor-compression refrigeration system

Based on the above mechanism, the cooling effect comes from the entropy change of the MCE materials. Hence magnetic refrigeration does not need any traditional coolants. On the other hand, with some advanced MCE materials such as praseodymium-nickel alloys, it can create an extremely low temperature environment. Previously, it enabled scientists to approach within one thousandth of a degree of absolute zero [13]. Its excellent cooling effect will also aid the operation of superconducting bearings mentioned earlier. Therefore, it can promote cleaner operation for modern refrigerating systems without the risk of damaging ozone-layer.

Magnetism

Magnetic dipoles disoriented



MCE Materials

Magnetic dipoles

Thermodynamics

MCE material heats up

External magnetic field applied, magnetic dipole oriented

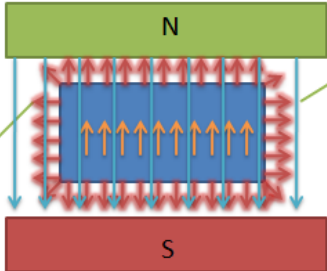

Magnetic Field lines

Heat is released

Disorderliness decreases and thus the entropy and heat capacity decreases. MCE materials becomes cooled.

MCE material undergoes demagnetization. Magnetic dipoles becoming disoriented and disorderliness increasing

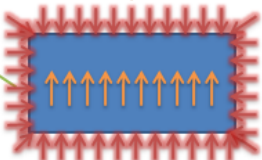

Heat is absorbed

Entropy increases and heat is absorbed from the surrounding, exhibiting refrigerating effect

Magnetic dipoles disoriented



MCE material heats up

Cycle repeats

Figure 9-7 Schematics showing the mechanism of magnetic refrigeration

9.4.5 Obstacles and vision

Magnetic refrigeration is still at the stage of development because current MCE materials have a lot of constraints. One of them is the hysteresis loss under sweeping magnetic field. New materials for magnetic refrigerating systems are needed. One of the possible materials is lanthanum-iron-silicon alloy $\text{La}(\text{Fe},\text{Si})_{13}$ [14]. $\text{La}(\text{Fe},\text{Si})_{13}$ is an alloy which exhibits significant reduction of thermal and field hysteresis. Therefore, the use of $\text{La}(\text{Fe},\text{Si})_{13}$ can shorten preparation time and decrease cost in magnetic refrigeration.

9.5 Outlook

Engineers and scientists' continuous efforts have made enormous progress in clean energy research and development based on magnetism. Nevertheless, there are still many technical barriers.

First, operating temperatures of current superconductors are still too low. This makes applying superconducting bearings in wind turbines and flywheel systems difficult. Keeping the bearings at low temperature requires a strong cooling unit which consumes a lot of energy. The recent research in high-temperature superconductors may provide a feasible solution, yet more effort is needed to develop a room-temperature superconductor for clean energy generation. Magnetic refrigeration has many merits, yet it suffers from low efficiency because of serious hysteresis loss in current MCE materials. Better MCE materials have to

be developed to decrease the hysteresis loss and improve their performance. In fusion power, a stable and extremely high-temperature environment with high-density plasma can be produced by using levitating dipole technology. This research is still in its infancy and hopefully it can become practical in the near future.

Clean energy and environment is the most important issue for the 21st century. Through continuous research and cooperative efforts, magnetism will surely take an important role in assisting the large-scale deployment and utilization of clean technologies and providing a cleaner environment for generations to come.

Reference

- [1] D.G. Christopher and R. Beach, "Flywheel technology development program for aerospace applications," *Aerospace and Electronics Conference, 1997. NAECON 1997*, vol. 2, pp. 602-608, 1997.
- [2] D.L. Chandler, "Levitating magnet brings space physics to fusion," 2010. [Online] Available: <http://web.mit.edu/newsoffice/2010/fusion-ldx-0125.html>
- [3] A. Iiyoshi and K. Yamazaki, "The next large helical devices," *Physics of Plasmas*, vol. 2, no. 6, 1995.
- [4] A. C. Boxer, R. Bergmann, J. L. Ellsworth, D. T. Garnier, J. Kesner, M. E. Mauel,

- P.Woskov, "Turbulent inward pinch of plasma confined by a levitated dipole magnet," *nature physics*, vol. 6, pp. 207-212, 2010.
- [5] M.J. Prather, R.T. Watson, "Stratospheric ozone depletion and future levels of atmospheric chlorine and bromine," *Nature*, vol. 344, pp.729-734, 1990.
- [6] L.T. Gidel, P.J. Crutzen, and J. Fishman, "A Two-Dimensional Photochemical Model of the Atmosphere 1: Chlorocarbon Emissions and Their Effect on Stratospheric Ozone," *Journal of Geophysical Research*, vol. 88, pp. 6622-6640, 1983.
- [7] H. Slaper, G.J.M. Velders, J.S. Daniel, F.R. de Grujl and J.C.V. der leun, "Estimates of ozone depletion and skin cancer incidence to examine the Vienna Convention achievements," *Nature*, vol. 384, pp. 256-258, 1996.
- [8] S.K. West, D.D. Duncan, B. Muñoz, G.S. Rubin, L.P. Fried, K. Bandeen-Roche, O.D. Schein, "Sunlight Exposure and Risk of Lens Opacities in a Population-Based Study," *The Journal of American Medical Association*, vol. 280, no. 8, pp. 714-718, 1998.
- [9] J.M. Calm, D.J. Wuebbles, and A.K. Jain, "Impacts on global ozone and climate from use and emission of 2,2-dichloro-1,1,1-trifluoroethane (HCFC-123)," *Climate Change*, vol. 42, pp. 439-474, 1999.
- [10] B. Podmiljšak, "The magnetocaloric effect," *Jožef Stefan International Postgraduate School. Seminar for the lecture "Physics of materials"* [Online] Available: www.ijs.si/~kutnjak/reprints/Magnetocaloric.pdf
- [11] A.M. Tishin and Y.I. Spichkin, *The magnetocaloric effect and its applications*. Bristol and Philadelphia: Inst. Phys. Publ, Institute of Physics Publishing, 2003.
- [12] F.C. Fernandez, PhD Thesis, *Magnetocaloric effect in Gd₅(SixGe_{1-x})₄ alloys*, vol. 66, 2001.
- [13] J. Emsley, *Nature's Building Blocks*, Oxford University Press, p. 342, 2001.
- [14] J. Lyubina, O. Gutfleisch, M.D. Kuz'min, M. Richter, "La(Fe,Si)₁₃-based magnetic refrigerants obtained by novel processing routes," *Journal of Magnetism and Magnetic Materials*, vol. 321, no. 21, pp. 3571-3577, 2009.

Section 4 Innovations and Applications

KNOWLEDGE 知識



HERITAGE 傳承

服務 SERVICE



10 Open Innovation for Environmental Research

Jacqueline C.K. Lam, Clever Ng and Peter Hills
The Kadoorie Institute, the University of Hong Kong

Abstract

Innovation plays a key role in driving industries to gain competitive advantage. Increasingly, open innovation is considered a key driver to help industries accelerate the rate of innovation through exploitation of the free flow of internal and external knowledge and expertise. It is believed that industries will thus acquire stronger capability for innovation given the external input of expertise and knowledge that complements their internal capabilities. As a result, such businesses can achieve higher industrial competitiveness than those which rely only on traditional closed innovation approach. University-industry collaboration can be considered as a form of open innovation. Industries, especially small and medium enterprises, are particularly interested in partnering with universities as niche collaborators due to their innovation competence.

In face of intensive competition from other neighboring cities in China like Shenzhen, Shanghai and Beijing, and neighboring countries like Singapore, Hong Kong has increasingly attempted to achieve economic

competitiveness through innovation. University-industry collaboration has been increasingly advocated by the government as an effective means for innovation, such as the development and commercialization of niche technologies for the environment. In 2009-2010, Hong Kong ranked third in Global Innovation Index, out of 132 economies surveyed. In terms of university-industry collaboration, Hong Kong ranked twenty-seven. To gain a deeper understanding of what determines industry-university innovation, this study focusses on all cleaner energy and environmental-oriented Innovation-and-Technology (ITF) funded projects that have been approved since the establishment of Hong Kong Innovation and Technology Fund in 1999 and that have involved university-industry collaboration. A total of 145 out of 2,345 ITF funded projects that carry the theme of cleaner energy and environment research and development during 1999-2010 have been selected. Quantitative surveys and qualitative face-to-face interviews have been conducted to identify what drivers and barriers for this group of ITF industries are involved in their engagement in industry university collaboration, and why these drivers and barriers exist. The

result obtained shows that majority of the local industries surveyed and interviewed are eager to collaborate with universities in environmental innovation for competitive advantage, especially for gaining reputations and securing future business opportunities. However, huge obstacles exist for local industries to partner with universities, especially for the SMEs, due to policy and institutional constraints. Innovation policies in support of SME innovation and institutional mechanisms to help SMEs find the right university partners are particularly relevant and critical for promoting open innovation (in the form of university-industry collaboration) in environmental and cleaner energy research among local industries in future.

10.1 Introduction

In many countries, innovation plays a key role in driving industries and businesses to gain competitive advantage (Porter, 1998). Increasingly, open innovation is considered a key driver in helping industries accelerate the rate of innovation through exploitation of the free flow of internal and external knowledge and expertise. It is believed that industries will thus acquire a stronger capability for and increase their rate of innovation given the external input of expertise and knowledge that complements their internal capabilities, as a result achieving higher industrial competitiveness than those which rely only on traditional closed innovation

approach (Chesbrough, 2003). Industry-University Collaboration (IUC) is considered a form of open innovation. Industries, especially small and medium enterprises, are particularly looking for universities as niche collaborators as they can obtain the needed innovation competence that they are lacking through university partnership (Schiensstock and Hämäläinen, 2009).

In face of intensive competition from other neighboring cities in China such as Shenzhen, Shanghai and Beijing, and neighboring countries such as Singapore, Hong Kong has increasingly attempted to achieve economic competitiveness through innovation. IUC has progressively been advocated by the government as an effective means for innovation, especially for developing and commercializing niche technologies in various domains, including the environment (Invest HK, 2011). In 2009-2010, Hong Kong ranked third in the Global Innovation Index out of 132 economies surveyed. In terms of university-industry collaboration, Hong Kong ranked twenty-seven (Insead, 2010). It would thus be interesting to observe what drivers and barriers to IUC have influenced industries engaging in innovation in Hong Kong. This study will look at one of the government-selected industries for innovation, the environmental industry, and identify ways to further enhance the sector's technology and innovation competence by means of open innovation – IUC, thereby

contributing to enhancing Hong Kong's economic competitiveness in the long term.

IUC has been used as a strategy by industries/universities to enhance or speed up the process of innovation. In general, the key drivers to IUC include the economics of innovation: rising costs of production and decreasing revenues from closed innovation (Chesbrough *et al.*, 2006; Melese *et al.*, 2009); reputation management (Fontana *et al.*, 2006); government policies and incentives (Van Looy *et al.*, 2003; Hershberg *et al.*, 2007); openness culture (Van Looy *et al.*, 2003; Laursen and Salter, 2004; Fontana *et al.*, 2006); and reliance on university for expertise and equipment for enhancing internal R&D capability (Fontana *et al.*, 2006; Melese *et al.*, 2009). The key barriers to IUC include fear of disclosure to third parties (Melese *et al.*, 2009), and cultural, norm and value gaps between industries and universities (Fontana *et al.*, 2006; Melese *et al.*, 2009). For instance, as industry and university have different research objectives/foci, some industries may find it difficult to cope with the open innovation culture, lack of coordinating/bridging mechanisms (collaboration ad-hoc and opportunistic, often based on personal relationships), duration of innovation involved (Melese *et al.*, 2009), and problems associated with the distribution and sharing of resources (e.g. budgeting and staffing) (Melese *et al.*, 2009).

Other firm characteristics also affect companies' involvement in IUC. Company size and innovation intensity, and the nature of company business have an impact on IUC. Companies that have a higher dependence on science or engineering, e.g. pharmaceutical or nanotechnology firms, carry a higher track record of IUC (Lausen and Salter, 2004; Fontana *et al.*, 2006; Parkmann and Walsh, 2007). This is the same with companies that have a higher R&D intensity (Lausen and Salter, 2004; Fontana *et al.*, 2006), and, larger firm-size (Fontana *et al.*, 2006). To date, successful cases of open innovation are limited to multinational companies and high technology companies with a considerable company size and capital in global context (Chesbrough, 2003; Herzdog, 2009). Not much work has been done to investigate Hong Kong in the area of green technologies and the potential for local industries to make good use of IUC for enhancing their competitive advantage. This study intends to close the research gap.

10.2 Methodology

To understand the drivers and barriers pertaining to IUC within the context of Hong Kong, a research project was conducted with industries that have successfully obtained project funding from the Hong Kong Innovation-and-Technology Fund and that have been involved in university-industry collaboration during the period of 1999-2011.

Clean Energy and Environment

As of October 2010, a total of 145 out of 2345 ITF funded projects fall into the environmental category, 89 of them involving industry-university collaboration.

A closer look at the 89 collaborative projects reveals that 29% of the collaborative projects are energy-related, and within this category renewable energy represents 27% of the total (see Figure 1).

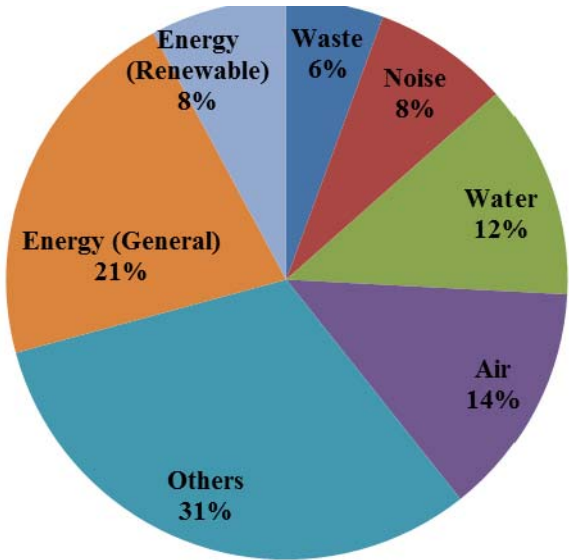

Figure 10-1 *Composition of Industry-University Collaborative ITF-funded Environmental Projects*

To identify the key drivers and barriers for industries to take part in IUC and the types of IUC that these parties have established, an

online-quantitative survey was distributed during October 2010 – March 2011 to all coordinators/deputy coordinators of the companies who partnered with universities in environmental-related funded projects. A total of 12 companies have completed the online-questionnaire. To gain a deeper understanding of how these drivers/barriers influence UIC and how open innovation affects the company’s competitive advantage, we have conducted qualitative face-to-face interviews. 4 companies, including 2 large and 2 SME companies, have been selected for interviews.

12 respondents have completed the survey and responded to our interview. The respondents are top decision-makers of their company, normally in charge of the R&D team, and project coordinators/deputy project coordinators of the ITF-funded environmental projects. Of the 12 companies surveyed, the majority of the companies are SMEs (10 of them having no more than 50 research and non-research personnel); only 2 companies are comprised of a company size of more than 150 staff (including research and non-research staff), and are grouped as large companies. The amount of funding obtained for each ITF project ranged from \$165,000 to \$2,655,000, covering environmental topics ranging from air, water, waste, and energy, to other issues such as climate change, material science, and environmental health and safety.

10.3 Survey Results

Drivers and Barriers to IUC for Environmental ITF-funded Projects in Hong Kong

The survey attempts to understand the key barriers and drivers affecting decisions of industries involved in ITF-funded environmental projects to collaborate with university partners, the form of IUC they have established, and what areas of competitive advantage these IUC open innovation environmental projects bring to their companies.

A question was raised concerning the key drivers for the ITF-funded industries to adopt IUC for their environmental projects. Among all respondents, “innovative and unique business model with the potential to increase our company’s competitive advantage” topped the list of key drivers for companies to adopt IUC (55% of surveyed companies). In addition,

reputation management, pressure to produce more innovative and user-friendly products, emerging culture for open-innovation in their own business field, limited firm-internal innovation potential, and scale, constituted the second tier driving factors (36%) motivating companies to seek an open innovation approach for R&D through collaborating with universities. However, at the moment, there are few motivations for the surveyed companies to engage in IUC for ITF-funded environmental projects for the sake of skill and knowledge leveraging, compliance with strict environmental standards, intensive competition in the technology market (27%), or for enabling the voice of external stakeholders (18%). Other additional drivers cited by the surveyed companies included: same mission and interests with external partner, and the need to look for external funding and resource support due to limited support from the government for innovation (18%) (see Figure 2).

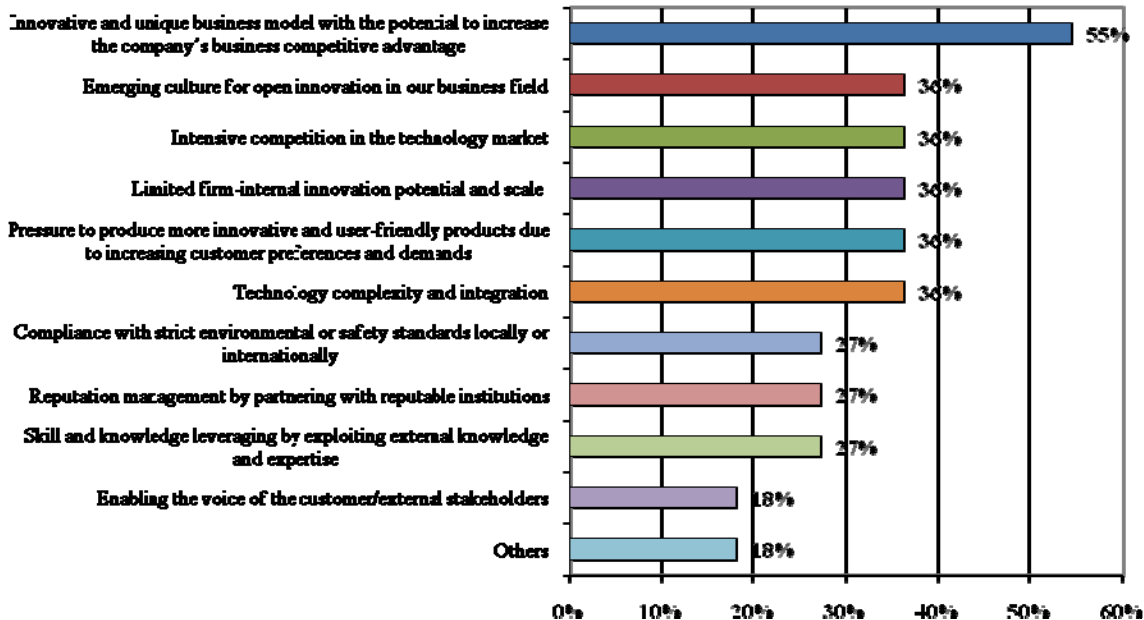

Figure 10-2 Drivers for industries to collaborate with university in ITF environmental projects

To understand the key barriers for the industries to adopt IUC open-innovation for their ITF-funded environmental projects, the majority of companies revealed in the survey that they considered the unavailability of competent external partners to provide the necessary knowledge and technologies for IUC as the key barrier (58%), and the fear of disclosure of their own intellectual property to external partners became the second top rated key barrier (50%). For some companies, innovation was considered a rather easy task and companies did not think they needed to rely on external partners to achieve the target, which was considered by

some a key barrier to IUC (33%). A small number of companies named strong internal competence, difficulty in integrating external and internal knowledge, higher uncertainty and unpredictability concerning overall planning and implementation of IUC projects, as well as the lack of demand for generation of knowledge and technologies that are more client/user responsive (25%) as key barriers. Very few companies considered the absence of corporate policies to incorporate external ideas (8%) as a key barrier. In addition, the lack of funding support, small company scale for R&D, immature technology market, the observation that a lot of claimed

Clean Energy and Environment

open innovations are not yet ready for commercialization, and uneven distribution of risks and benefits between industries and universities, were considered by some companies as key barriers (25%). Interestingly, no companies considered that existing

legislation, norms and regulations had discouraged IUC, or that resistance to involving external parties by corporate management was a key barrier to IUC (See Figure 10-3).

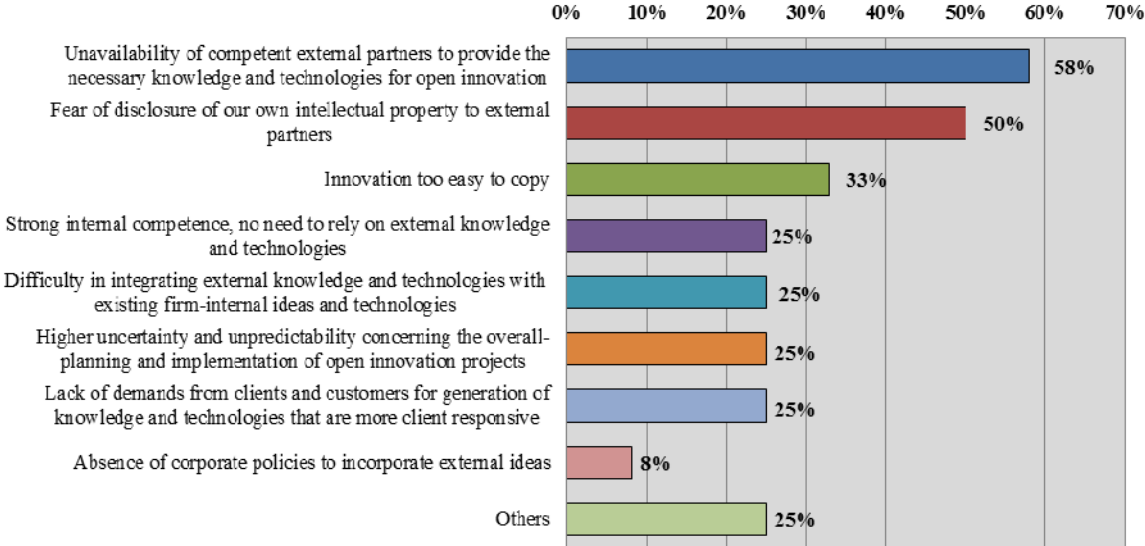

Figure 10-3 Key Barriers for Industries to Collaborate with Universities

An important question was raised over whether an open innovation approach in the form of IUC has led to higher competitive advantage. There was a strong view held by the surveyed companies regarding the overall enhancement in company competitive advantage as a result of collaboration with university partners on ITF-funded environmental projects (Mean Score =

4.45). This group of companies strongly believe that an open innovation approach can lead to higher profitability of open innovation products and services (Mean Score = 4.18); as well as higher user/customer satisfaction (Mean Score = 4.09); and higher innovation competence (Mean Score = 4.00). Companies held neutral to strong views regarding the following aspects of competitive advantage as a result of adopting

the open innovation approach in the form of IUC, including: reputation management (Mean Score = 3.64); higher cost-saving and

outcompeting industry/business partners (Mean Score = 3.55) (see Figure 4).

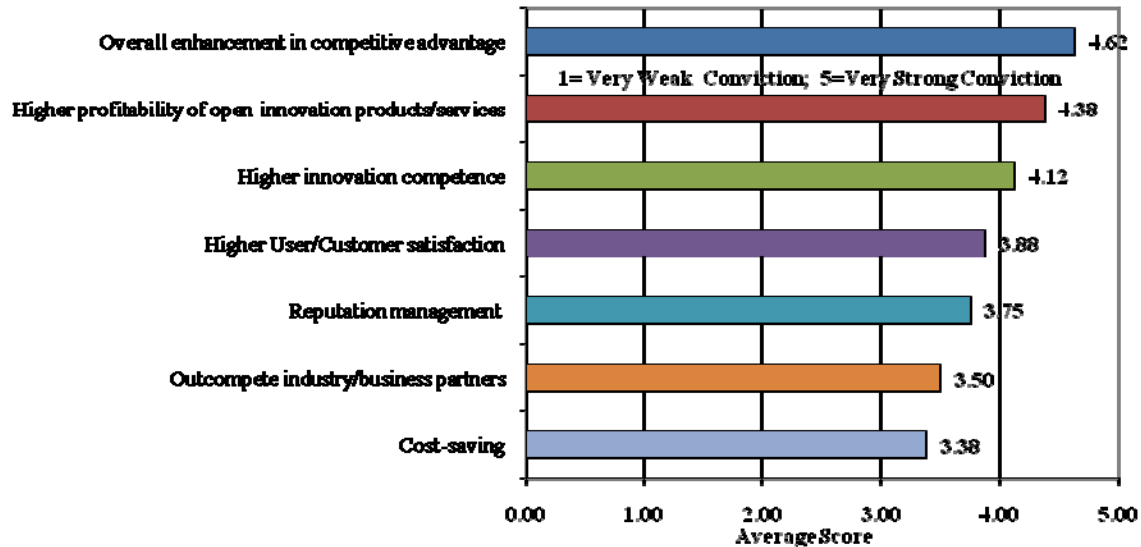

Figure 10-4 Competitive advantage achieved after engaging in Industry-University Collaboration

It would be interesting to understand what types of collaboration companies engaged in ITF-funded environmental projects had established with their collaborators. The use of codified scientific knowledge accessible through scientific publications, conferences and networking with collaborator, the less institutionalized form of collaboration (58%) became the most popular type of collaboration between industries and university partners,

followed by integration of users' feedback (50%), and more institutionalized forms of collaboration, covering both inter-organizational arrangements for pursuing collaborative R&D (42%), as well as commissioned contract research and consulting between both parties (42%). Industries, however, did not collaborate frequently with universities by means of human resource transfer (25%) or by informal interaction (25%) (see Figure 5).

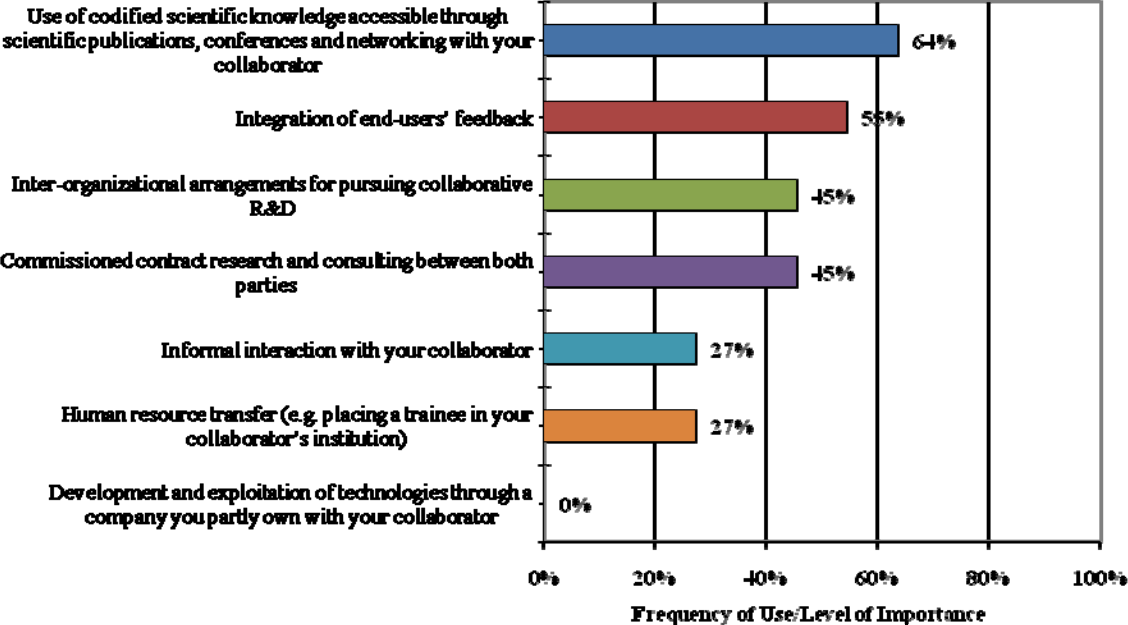

Figure 10-5 Types of Collaboration in Industry-University Collaboration

Finally, concerning the types of external source that industries would frequently use and consider as important external sources in generating ideas or innovations, it is interesting to note that customers were the most frequently used and the most important external source of ideas and innovations (Mean Score = 3.5), followed by lawmakers/regulators (Mean Score

= 3.2), universities (Mean Score = 2.8), research institutes (Mean Score = 2.6), and engineers/consultants (Mean Score = 2.5). Although all companies surveyed had partnered with universities for ITF-funded environmental projects, universities had not been considered the most important external source for generating ideas and innovations (see Figure 10-6).

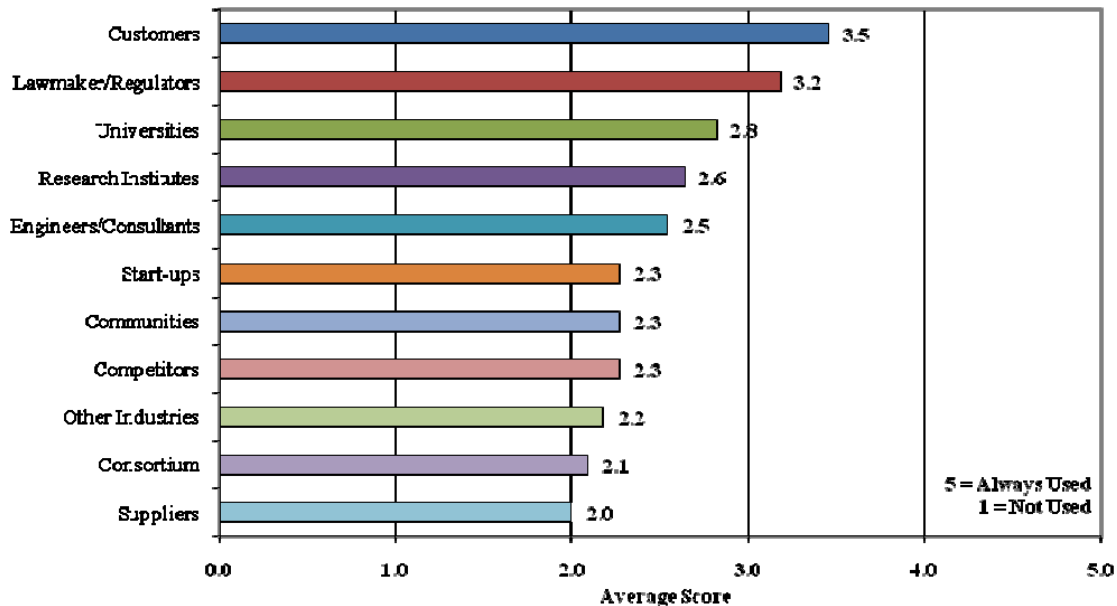

Figure 10-6 Reliance on External Sources for Ideas and Innovations

10.4 Discussion

10.4.1 Open Innovation Drives Competitive Advantage

The quantitative results and case study findings confirm that there is general recognition among the industrial R&D executives that open innovation, such as IUC in ITF-funded environmental projects, has enhanced their company's competitive advantage. The general agreement that competitive advantage has led to higher profitability and innovation competence reinforces the conception that open innovation

provides a good opportunity for companies to gain competitive advantage (Chesbrough, 2003, Chesbrough *et al.*, 2006). Case studies conducted with SMEs and large IUC companies have revealed that competitive advantage as a result of their engagement in IUC open innovation projects differ in dimensions. Whilst large companies cite the security of future business opportunities and maintenance of a continual positive relationship with clients/customers as two prominent areas of competitive advantage as a result of IUC - open innovation, SME companies have highlighted additional aspects such as product differentiation and profitability.

Innovation turns useless into useful

CYBERPORT
數碼港

I love Green Cyberport

玻璃樽回收計劃

GLASS RECYCLING PROGRAMME

平均每兩個回收玻璃樽便可循環再造成一塊環保玻璃磚
為環保出一分力，請將玻璃樽投入數碼港內的收集箱。

Approximately every 2 collected bottles can be recycled into 1 glass paver.
Take part in this green programme and place your unwanted glass bottles into recycling containers at Cyberport.

環保玻璃磚 Glass paver

GREEN LIVING
綠色生活
Join us in protecting the environment
攜手保護環境

查詢 Enquiry : 3166 3111

10.4.2 Key Drivers for IUC Open Innovation

Quantitative data show that the development of an innovative and unique business model with the potential to enhance a company's competitive advantage tops the list of drivers for IUC – open innovation. Cultural factors, technology complexity, limited firm-internal potential and scale, and increasing customer demands for more innovative products create considerable impetus for companies to take the open-innovation pathway by collaborating with universities (see Figure 10-2).

A closer look at the composition of the survey respondents reveals that the majority are SMEs (10 out of 12 companies). These companies are searching for innovative and unique business models to enhance their innovation capabilities, as SMEs generally lack such capabilities in house. Large and small companies look to universities for collaboration to enhance product differentiation and reputation management. Innovative products developed in partnership with universities are considered by clients/customers as more credible and reputable and therefore more competitive in the market. The drivers we identified are consistent with the findings from the literature review on drivers of IUC (see Section 10.1).

10.4.3 Key Barriers to IUC Open Innovation

SMEs are generally characterized by small size and capital ownership, lack of expertise and

resources, and weak networking capability. Universities generally do not find them an attractive partner to work with. This explains why 58% of the survey respondents cited the unavailability of competent external partners to provide the necessary knowledge and technologies for open innovation as the key barrier to IUC (see Figure 10-3). University partners are often not readily available for partnership. SMEs also find it difficult to locate the right candidate for IUC, due to the lack of appropriate institutional mechanisms to match the industrial and university partners. SMEs often miss the opportunities for innovation because of their relatively weak networking capability. Furthermore, the fear of the disclosure of one's own intellectual property to external partners also created another major barrier (50% of agreement) for collaboration with universities in open innovation environmental projects (see Figure 10-3).

10.4.4 Industry-University Collaboration: To Be or Not to Be

Companies are keen to work with universities to acquire ideas and innovation, as universities have good mastery of knowledge and technology and offer a higher chance for success, with a good track record of research ethics and good observers of intellectual property rights. Even though the ITF-funded companies gained competitive advantage through collaboration with universities, in reality, the surveyed companies seem to be

hesitant with IUC. Although universities are attractive partners, they are often not the right candidate for partnership. These companies prefer working with other external partners such as customers. As shown by the quantitative survey, customers (Mean Score = 3.5) and law-makers (Mean Score = 3.2) are more likely to be partners for ideas and innovations. The scores for universities (Mean Score = 2.8) or research institutes (Mean Score = 2.6) are consistently lower (see Figure 6). Companies, especially SMEs, find it hard to persuade universities for partnership because of their small size and scale of operation and innovation competence, lack of investment funding, and weak networking capabilities, companies.

10.4.5 The Constraints of Local Industries under the Current Funding and Institutional Mechanisms for Technology and Innovation

In Hong Kong, local industries can apply for funding support through various schemes under the Innovation and Technology Fund. In particular, the Small Entrepreneur Research Assistance Programme is set up to support SME innovation. As of 2011, a total of 5798.8 million dollars have been delegated to support 2,345 ITF-funded projects, amongst which only 6.3% is allocated to SMEs under SERAP (Innovation and Technology Commission, 2011a). However, there is a restriction imposed on SMEs in the applications. SMEs are required to contribute 50% of the overall project cost. The University-Industry Collaboration Programme mainly supports collaborative research projects that

involve private companies engaging in commercial business as the applicant, university as a partner, and under the stipulation that 50% of the project cost must be borne by the participating company (Innovation and Technology Commission, 2011b). Other funding schemes, for instance the Innovation and Technology Support Programme and the General Support Programme, are mainly reserved for government-funded R&D centres, academic institutions, or government-related organizations. The current funding mechanism has left little room for industries to self-initiate innovation projects. Industries are either handpicked by universities and other research institutions as collaborative partners or they do not have enough financial funding to kick start innovation. Institutional mechanisms are not readily available to help industries select the most relevant university partner that fit their requirements. While large industrial companies have to rely on their own networks to search for the right candidates, small companies have no such privilege and have to try their own luck.

10.4.5 Policies and Institutional Arrangements for Promoting IUC

In view of the situation above, two measures are necessary to move local industries out of the current deadlock and enable them to take advantage of IUC open-innovation. They include funding support for SMEs in technology development and innovation, and institutional mechanisms to help local industries locate the right university collaborators

Top innovative countries have focused on supporting SMEs for innovation. Government support mainly consists of monetary funding and the provision of technical know-how. In Germany, up to 450 million Euros of funding support was given to assist SMEs under the ZIM programme during 2009-10. In Sweden, although the SME sector is not a major contributor to R&D, their policies encourage SMEs to innovate. Between the years 2006-2008, the Swedish Agency for Innovation Systems provided 36 million Euros to 360 companies through its “Research and Grow” programme for the SMEs to directly support the SME sector for innovation. Indirect support was provided to let SMEs have access to people with experience in innovation and R&D. In 2006-2007, 67% of the projects involved new collaborations with R&D performers, universities, research institutes or other companies. In Denmark, direct and indirect support was given to support SME innovation. A “double-up” initiative started in 2008 with a funding of DKK 30 million plans to offer public co-financing of research projects between SMEs and academic and research institutions. Institutional mechanism was established to serve as the portal to help SME obtain knowledge from academic and research institutions. For instance, under a programme “Regional Innovation Agents”, SMEs which are not traditionally innovative were contacted to encourage them to imitate regional “innovative agents” through innovation and knowledge

collaboration. Other indirect support was given to SMEs by means of a mentorship scheme. The purpose of the planned scheme was to loan experienced and competent industry managers to SMEs so as to provide them with the right competence and tools for innovation management and to help them develop right strategies leading to innovation (Capgemini Consulting, 2010)

Promoting industry-academic linkage is a prominent trend across top innovative countries in the world; it also constitutes a key pillar of innovation strategies. This linkage is promoted in a number of ways, including: companies promoting commercialization in universities, increasing the number of industrial PhDs co-supervised by industrial enterprises and universities, launching innovation funds to promote entrepreneurship education and technology incubators in universities. In Denmark, promoting interaction and the infrastructure between the research and industry communities are among the key foci of the Danish government. An action plan was developed by a Danish government institution to promote more innovation and effective knowledge dissemination during 2007-2010. The plan covered the SMEs and called for the strengthening of knowledge dissemination and interaction between the research community and industry (Capgemini Consulting, 2010).

Among top innovative countries, direct funding support in the form of public co-financing of

collaborative projects between industrial enterprises and academic institutions is a good strategy to encourage the local industries. It is especially helpful in engaging SMEs to participate IUC. However, it must be complemented by institutional support. For instance, a portal can be set up to help industries obtain knowledge and expertise from academic and research institutes. Mentorship schemes can be promoted through loaning experienced and competent industrial personnel to the market. Better interaction and infrastructure building can be encouraged in industrial-university collaboration. New funds can be injected to strengthen the linkage between local industries and universities such as entrepreneurship education and technology incubators in universities.

10.5 Conclusion

Hong Kong's industries are at a cross-road. 98.9% of them are SMEs (Trade and Industry Department, HKSAR Government, 2011). With increasing competition from neighbouring cities, such as Shanghai, Beijing and Shenzhen in mainland China, Hong Kong's industries should turn to innovation for enhancing their competitive advantage and securing their competitiveness in the long-term. However, SMEs are characterized by their small size and scale of operation with weak innovation competence, which makes it an attractive idea for them to open innovation by relying on external parties to strengthen their internal

innovation capabilities through capitalizing on external resources and expertise. Collaborating with universities becomes the single most preferred option but huge barriers exist.

Surveyed and interviewed companies which have engaged in ITF-funded environmental projects reveal that companies perceive that there are definite competitive advantages for collaborating with universities, but find that universities are highly hesitant about the idea of collaboration with SMEs. Universities find SMEs not attractive enough with their small size and limited capital, as well as innovation competence. Their plights can be demonstrated by a company interviewed which is keen on collaborating with universities but experiences repeated declines from universities because of the lack of substantial benefits that universities foreseen to be reaped from such collaboration. Though they were able to secure one university partner to collaborate in a renewable energy project at the initial phase of innovation the university had declined to continue the partnership during the second phase.

Compounded by SMEs' weak networking competence, the current situation makes it very difficult for local industries to adopt an open innovation approach and collaborate with universities in environmental and cleaner energy research. Given that 98.9% of Hong Kong's manufacturing industries are SMEs, for the sake of Hong Kong's long term competitiveness, it is vital for the Hong Kong government to

investigate new ways of engaging the local industries, especially the SMEs in IU collaborative innovation projects, by providing relevant direct or indirect supports, including funding and institutional support for the local SMEs. With reference to top innovative countries in the world, more direct funding support, for instance, public co-financing of collaborative projects between industrial enterprises and academic institutions is a good strategy to encourage the local industries to innovate – especially the SMEs. Given the weak networking capability with universities by the SMEs in Hong Kong, complementation by institutional support by, for instance, providing mentorship through loaning experienced and competent industrial personnel to the industries; providing a portal to help industries obtain knowledge and expertise from academic and research institutes; promoting interaction and providing infrastructure to encourage IUC; and injecting funds to help strengthen the linkage between local industries and universities; is necessary to help Hong Kong SMEs enhance their competitive advantage through open innovation in the form of IUC.

Acknowledgement

The assistance of Miss Esther Wong in editing this article is gratefully acknowledged. All errors remain the authors.

Reference

1. Capgemini Consulting, 2010, *Benchmarking Study on Innovation Policy*, CC India, Research Services.
2. Chesbrough, H.W., 2003, *Open Innovation: The New Imperative for Creating and Profiting from Technology*, Cambridge, Harvard Business School Publishing.
3. [3] Chesbrough, H., W. Vanhaverbeke, and W. en West, J., 2006, *Open Innovation: Researching a New Paradigm*, Oxford University Press.
4. Fontana, R., Geuna, A., Matt, M., 2006, Factors affecting university-industry R&D projects: The importance of searching, screening and signalling, *Research Policy*, **33**, 309-323.
5. Herzdog, P., 2009, Innovation and the open innovation concept, *Open and Closed Innovation: Different Cultures for Different Strategies*, Gabler.
6. Hershberg, E., Nabeshima, K., Yusuf, S., 2007, Opening the ivory tower to business: university-industry linkages and the development of knowledge-intensive clusters in Asian cities, *World Development*, **35**, **6**, 931-940, doi:10.1016/j.worlddev.2006.05.006.
7. Innovation and Technology Commission, HKSAR Government, 2011a, *Innovation and Technology Fund Statistics of Approved Projects*,

- <http://www.itf.gov.hk/1-eng/StatView101.asp>
8. Innovation and Technology Commission, HKSAR Government, 2011b, *About the Innovation and Technology Fund*, <http://www.itf.gov.hk/1-eng/about.asp>
 9. INSEAD, 2010, Global Innovation Index Report 2009-2010, INSEAD and India's Confederation Industry, http://www.globalinnovationindex.org/gii/main/reports/2009-10/FullReport_09-10.pdf
 10. Laursen, K., Salter, A., 2004, Searching high and low: what types of firms use universities as a source of innovation? *Research Policy*, 33, 1201-1215.
 11. Melese, T., Lin, S.M., Chang, J.L., Cohen, N.H., 2009, Open innovation networks between academia and industry: an imperative for breakthrough therapies, *Nature Medicine*, 15, 5, 502-507.
 12. Perkmann, M., Walsh, K., 2007, University-industry relationships and open innovation: Towards a research agenda, *International Journal of Management Reviews*, 9, 4, 259-280, doi:10.1111/j.1468-2370.2007.00225.x.
 13. Porter, M., 1998, *Competitive Strategy*, Free Press.
 14. Schienstock, G., Hämmäläinen, T., 2007, *Transformation of the Finnish Innovation System: A network approach*, Sitra Reports, Helsinki, Hakapaino Oy.
 15. Trade and Industry Department, HKSAR Government, 2011, *Hong Kong: the Facts*, <http://www.gov.hk/en/about/abouthk/factsheets/docs/trade&industry.pdf>
 16. Van Looy, B., Debackere, K., Andries, P., 2003, Policies to stimulate regional innovation capabilities via university-industry collaboration: an analysis and an assessment, *R&D Management*, 33, 2, 209-229, Blackwell Publishing Ltd.

Green-roof and Green-wall Technologies Developed by an ITF-funded Companies in Hong Kong by Open Innovation - IUC

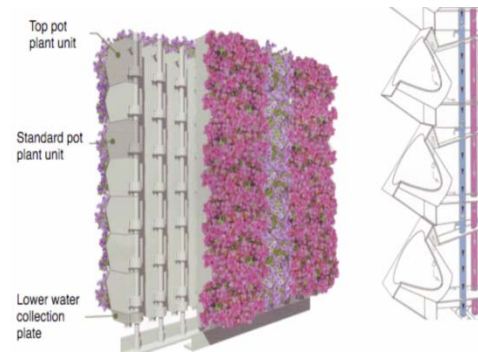

Barriers of IUC

- Time consuming
New collaborative partners need to be brought up-to-speed and gain familiarity with research topics
- Time constraint in short-term internship programme for students may be inadequate in allowing collaborative R&D to be conducted

Drivers of IUC

- Ability to develop a new business model for enhancing competitive advantage
- Business trust – gain credibility through collaboration with university
- Prospect of future business opportunities
- Long-term competitive advantage

Courtesy of Everplant Technology Ltd.



11 Case: Town Island Renewable Energy Supply System

C.C.Ngan, T.K.Chan, Raymond Ho, K.C. Cheng, Emmy Lee
CLP Research Institute

11.1 Introduction

This article presents a case study on a standalone renewable energy (RE) supply system developed by CLP Power, one of the electric utilities in Hong Kong, to provide electricity to the residents on a remote island. This is the first commercial RE supply system in Hong Kong that serves public customer and it has to comply with all regulatory requirements expected from public utilities and meet the stringent quality standards committed by CLP. In addition to generating electricity that has no carbon dioxide emission, this RE supply project help to create necessary local knowledge and expertise facilitating development of similar facilities in the region. In view of its uniqueness, the project also brings values by setting example on effective use of RE to serve remote community, supporting local education and research, and drawing public attention on electrification of remote island.

11.2 Town Island

Town Island is a remote island at the southern tip of Sai Kung Peninsula (Figure 11-1). Boat trip from Sai Kung to the island takes about one hour. It was uninhabited until 1970's when Hong Kong Government granted land on the island for Operation Dawn to operate a voluntarily drug rehabilitation centre. Eventually, the island is also known as Dawn Island. Due to remoteness of the island, Operation Dawn had to build its own facilities and run its own diesel generators and network to supply electricity to its facilities (Figure 11-2 to 11-7). Using diesel generator to supply electricity was environmentally unfriendly (air

and noise pollution, greenhouse gas emission) and expensive. Also, it was challenging for Operation Dawn to maintain necessary expertise and resources to take care of operation and maintenance of the diesel generators and network. The diesel generators were operated in specific periods of each day to reduce fuel consumption and noise pollution. Residents in the drug rehabilitation centre could not enjoy reliable and adequate electricity supply as other electricity customers in the urban area. Further expansion and development of the centre was somehow restricted.



Figure 11-1 Location of the Town Island
Located at the southern tip of the Si Kung Peninsula and requires an hour ride from Sai Kung Ferry Pier

Clean Energy and Environment



Figure 11-2 Drug rehabilitation centre



Figure 11-4 Kitchen



Figure 11-3 Church



Figure 11-5 Hostel



Figure 11-6 Diesel generator

11.3 Path towards a RE supply system

In early 2000's, Operation Dawn formally applied for electricity supply from CLP. Having considered the technical viability and cost of different supply options, CLP's preference was to extend the main power grid in Sai Kung area to the island via overhead line or submarine cable. Renewable Energy (RE) technologies were not mature enough and very expensive at that moment. Overhead line option was subsequently ruled out in view of its visual impact and concern on marine navigation safety. The next alternative of using submarine cable was then studied. Seabed investigation suggested that considerable measures such as

diverting the cable to longer route are necessary to protect the corals and other seabed ecologies around the area. All these studies and investigations, together with necessary consultation of Government departments and key stakeholders, were time consuming. In view of the maturity and cost reduction of solar and wind power technologies in the last decade, and CLP's commitment to reducing its carbon intensity since 2007, the RE supply option was revisited in 2008. It was found that the state-of-the-art RE technologies could adequately meet the load demand on the island and the cost of the RE supply system would be competitive with the submarine cable supply option previously considered. Eventually, CLP decided to build its first commercial standalone RE supply system to provide electricity to the island. This is a major milestone for CLP in its transformation towards a low carbon energy portfolio.

11.4 The Town Island RE supply system

11.4.1 RE option

Solar energy, the most dependable renewable resource on the island, is taken as the major energy source for the RE supply system. Long term solar radiation data are available from Hong Kong Observatory to support the energy yield analyses. Solar photovoltaic (PV) panel which can directly convert solar energy into electricity and has long term track record on reliability and performance is widely available in Asia Pacific region. Other RE supply options

such as wind, ocean and bio-fuel were ruled out because of lack of reliable resource data to support decision; immaturity or unavailability of related technology; or practical constraints such as safety and environmental impacts.

11.5 The RE supply system

After careful investigation of local RE market conditions and technical studies, the following key components and parts were outlined for the RE supply system:

- (i) 180 kilowatts (kW) of PV panels as the major generating source
- (ii) 12 kW of small wind turbines as supplementary generating source
- (iii) Battery to store excess electricity during sunny periods and maintain stable electricity supply in the rest of the time
- (iv) Power condition system to link up and manage the energy flows amongst all generating sources, battery and customer loads, and maintain a utility quality power supply to the island
- (v) Other balance of system such as mounting structure, plant room, switchgears, and control, protection and monitoring equipment, etc.

More technical information about this RE supply system is available from a dedicated project portal – https://www.clpgroup.com/poweru/eng/town_isl_and/index.aspx

11.6 The project team

This is the first commercial standalone RE supply system in CLP supply territory. Also, the relatively large capacity of the RE supply system makes it challenging for standalone operation. A dedicated project team with expertise in planning, regulatory liaison, RE technology, engineering design, land acquisition, procurement, construction, project management, operation and maintenance, and stakeholder engagement has been set up to implement this Town Island RE supply system project. Project team members work closely to address the challenges, develop solutions and communicate regularly to internal and external stakeholders to consolidate support and buy-in throughout the project. Dignity, passion and innovation help the team to weather through the challenges and uncertainties. Team members are proud of their contributions on this green initiative.

11.7 Project implementation

11.7.1 Phase One

Operation Dawn intends to re-develop its existing facilities and expand its operation on Town Island. The RE supply system has to cater for both the existing load and future development and, therefore, is installed in two phases. In Phase One, a 20 kW PV panel system was built and commissioned in early 2010 to supply the existing load on the island. This

Clean Energy and Environment

small RE supply system helps to reduce Operation Dawn’s own power generation with diesel fuel, and improve the quality, reliability and availability of electricity supply. Figure 11-8 to Figure 11-15 illustrate different stages in Phase One.



Figure 11-7 Site survey



Figure 11-8 Material delivery



Figure 11-9 Construction



Figure 11-10 PV panel installation

Clean Energy and Environment



Figure 11-11 Equipment installation



Figure 11-13 System completion



Figure 11-12 Testing

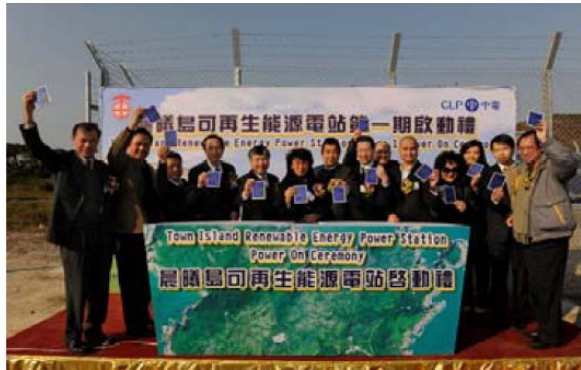

Figure 11-14 Power on

11.8 Phase Two

In Phase Two, the full RE supply system will be installed and commissioned in synchronism with the re-development of Operation Dawn's facilities which are expected to be completed in early 2012. This feature has vitally demonstrated a beauty of the RE supply system, namely, building up of the capacity can closely match the load demand growth! Detailed engineering design and permit application of Phase Two were started in last quarter of 2010.

11.9 The challenges

For a typical electricity supply project, one has to go through steps or tasks related to capacity planning, permit application, technology selection, engineering design, procurement, site construction, commissioning, and finally operation and maintenance. There is no exception to this Town Island RE supply system. Yet, compared to providing electricity supply via the main power grid, CLP has to face a new set of challenges in implementing this RE supply system. Sharing of these challenges would enhance local knowledge on RE deployment and facilitate development of similar RE supply system in Hong Kong and neighbouring regions.

11.9.1 Capacity planning

Capacity planning is, from an electric utility perspective, about formulating the appropriate supply capacities to cost effectively, adequately,

reliably and timely meet the expected load demand. In the case of Town Island, it might be the "mission impossible" (to size the system such that adequate and reliable electricity would be available in view of the intermittent and uncontrollable solar resource). Despite the use of battery to mitigate the impact from the intermittence of solar resource, one can only statistically project the adequacy and reliability performance of the supply system.

11.9.2 Permit application

Solar or wind based RE supply system has to be built on land with adequate area and favourable conditions (simple landscape, exposure to the resource). Land is not rare in Town Island but natural land suitable for erection of large number of PV panels is limited. Appropriate site formation is the engineering solution but this will mean additional cost, construction effort and disturbance to the natural environment. The project decided to go for minimum site acquisition to contain the cost, minimize disturbance and reinforce the "green" theme of the RE supply system. After all, acquiring land in Hong Kong is a lengthy and exhaustive process.

In addition to land acquisition, the RE supply system in Town Island has to, like other electric facilities developed and operated by CLP, obtain relevant environmental permit and approval, endorsement or appropriate "green light" from

various government departments (e.g. Buildings Department on the structural and civil designs) and statutory bodies (e.g. Town Planning Board). These processes add to the lead time, cost and management effort of the project.

11.10 Technology selection

Using RE to supply electricity is new to CLP. Careful choice of the RE technologies ensures the RE supply system can deliver expected performance and helps CLP, as the asset owner and operator, manage the underlying risks.

11.10.1 PV technology

Commercial PV products can be broadly divided into crystalline silicon (c-Si) and thin-film technologies. Whilst each technology has its own pros and cons, they are functionally acceptable for the Town Island application. c-Si PV was selected because of footprint constraint (i.e. maximum energy yield on limited land), availability of field operation track record and maturity of local supply chain.

11.10.2 Battery technology

Battery is another technology that draws considerable attention. Although there are many “powerful” storage technologies such as nickel and lithium batteries that are widely adopted in portable applications (e.g. digital camera, mobile phone), lead acid battery remains to be the most common and viable storage technology for large scale RE supply system because of cost and capacity consideration. The project team is

aware of the shortcomings of conventional lead acid battery (e.g. relatively short life time, limited deep discharge capability and heavy maintenance). High quality deep cycle battery that can withstand large number of deep discharge cycles is selected. The higher capital cost is more than offset by the longer life and lower maintenance requirement. The project also seeks the supplier’s agreement to recycle the battery at life end to minimize impacts to the environment.



Figure 11-15 Batteries of the Town Island PV System

11.10.3 Other technologies

Choice of other technologies in the RE supply system has taken into account the specific operating environment of the island (e.g. exposure to salty air and moisture, vulnerability to super typhoon, remoteness of the site) and maturity of local supply chain (e.g.

comprehensiveness and enforceability of warranty, availability of spare part, track record of the supplier). In short, choice of exact technologies for the Town Island RE supply system is more than a drawing board exercise but needs careful and balanced consideration amongst technical, commercial, regulatory and environmental factors, and maturity of local RE market.



11.11 Engineering design

Engineering design maps out the detailed civil, electrical and mechanical methods from which the RE supply system can be put together to achieve the desirable performance. One challenge, in the case of Town Island, is the lack of precedent case or local engineering standards to guide the designs. Overseas or international standards (e.g. IEC and ANSI) can serve as references but engineering judgments and support from local regulatory bodies are frequently needed to adapt these standards for local applications.

11.12 Site remoteness

Remoteness is the common challenge for many aspects of the project. Its impact on construction cost and time, and material and labour transportation are obvious. Construction and project management processes were modified (e.g. more pre-fabricated components) to reduce amount of on-site works. Remoteness is also an issue for future operation and maintenance of the RE supply system. Use of remote monitoring and control technologies, and support from residents on the island can help to mitigate but not eliminate this remoteness challenge.

11.13 Community values

This RE supply system can, when fully built and commissioned, deliver adequate, reliable and affordable electricity to the residents on Town Island. Compared with supplying electricity via power grid, the RE supply system would avoid about 7 tons of carbon dioxide emission per annum. In addition to these quantitative performances, the RE supply system brings the following values to the Hong Kong community.

11.14 Education and research

Despite its relatively small capacity and the remoteness of the site, this project has received much public attention and interest since start of Phase One development. The project sets a local precedent case of using RE to supply remote community on commercial basis. Knowledge and experience gained can help key stakeholders such as regulatory bodies,

engineering professionals, contractors and suppliers to better handle similar projects in the future.

CLP Management also envisioned the RE supply system in Town Island can deliver additional values to the community and therefore decided to use the RE supply system as a real example to support relevant research initiatives in local universities. This message was communicated to relevant engineering and science faculties in local universities. Subsequently, the project team reviewed the submitted research proposals and aligned three academic teams from HKU and PolyU to undertake research on RE and smart grid subjects. The project provides relevant operational data to support these researches. The research projects will last for one to two years and their research results will be shared in the public domain.

11.15 Community care and support

This RE supply project has drawn public attention on the stringent and primitive living environment on remote island in Hong Kong. For examples, volunteers from CLP help the residents on the island to recondition the aged and primitive wirings in their houses. They also educate the residents on means to conserve energy or use the electricity smartly and provide training on electrician skills to the residents in

the drug rehabilitation centre so that they will be better equipped for returning to the society

11.16 Conclusion

CLP has successfully developed the first phase of a RE supply system in the Town Island. This is the first commercial standalone RE supply system in Hong Kong. Despite its relative small capacity and remoteness of the site, the RE supply system is designed, built and operated up to the same standards and regulatory requirements for other power supply facilities in Hong Kong. Adoption of RE technologies under the established technical, commercial and regulatory frameworks in Hong Kong introduces a new set of challenges to the project team. Dignity, passion and innovation help the project team to cope with and resolve these challenges. Experience and knowledge gained from this project would facilitate development of similar projects in the region. The value of the RE supply system is more than generation of carbon dioxide free electricity. It helps the residents on the Town Island to improve their living standard and Operation Dawn to focus their resources on the operation of the drug rehabilitation centre. The project also provides education and research opportunities amongst local institutions to enhance their knowledge on a broad spectrum of energy subjects.

From Gown to Town Island

While our alumni contributed to a production project in the Town Island, our students Ms. Cindy Cheng also worked with the team and helped to conduct a research on the effect of weather condition to the efficiency of the solar power system. It was a good case of knowledge exchange and university and industry collaboration. Our alumni learnt technical knowledge from the University in the past. Now, they collaborate with our student and provide us an opportunity to research on a real application.

This collaboration also helps to incubate our next generation to equip with the advance and practical technologies, for the betterment of our environment in the future. This chapter is extracted from the technical paper of a Final Year Project. In this project, the local weather effect on the standalone PV system in Hong Kong was researched. The issues related to the data analysis of the Town Island Project, the performance of the PV system and its relationship with external factors and the characteristic of the PV system will be reviewed by our undergraduate student in this chapter.



12 Local Weather Effect on the Town Island PV system

T.K.Cheng¹ (Student), W. W. T. Fok¹(Supervisor)

¹Department of Electrical and Electronic Engineering, The University of Hong Kong



Cindy T.K. Cheng (EE3 student) and Ir. Raymond Ho (HKU EEE Alumni) on the island

12.1 Introduction

As described in Chapter 11, the PV system on the Town Island comprised PV arrays with a total capacity of 20 kW. It was installed in a small area located in the eastern side of the

Mount Carmel Hostel. There were associated distribution facilities for the improvement of reliability of electricity supply to the Island. In the phase I system, all the data was collected by some sets of PV inverters and bidirectional inverters for this research.

This research was jointly collaborated with the CLP Research Initiation (or CLP RI). The objective of this research was to study the performance and environmental factors of such a standalone PV power system, which is the first production site in Hong Kong. It is aimed to identify the difference between theories and simulations, as well as practical operation situation. In addition, the relationships among the external factors and the PV system were also analyzed. The results can provide us useful information for the modifications and improvements of the PV system the second phase.

12.2 Research methodologies

In this research, a number of methodologies such as clustering, statistic and data mining techniques were used to study the data provided by CLP Power and collected from the Hong Kong Observatory. The parameters of association, correlation and regression were analyzed.

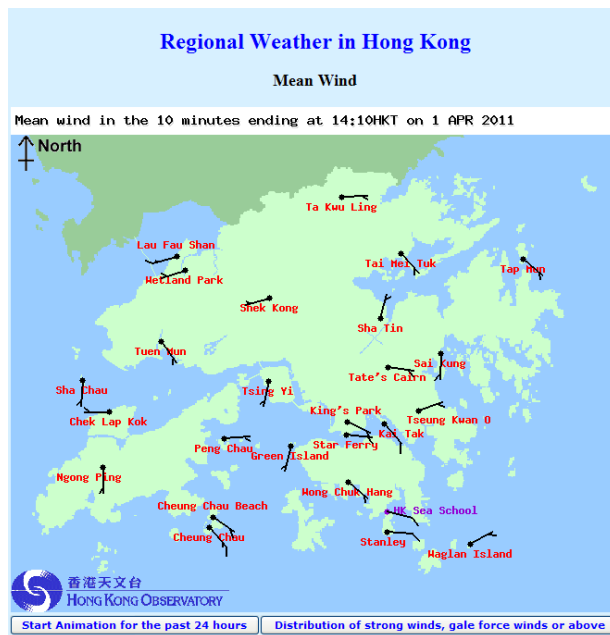

Figure 12-1 Wind speed data collected from the Hong Kong Observatory

The following procedures were performed:

- (i) Data Preparation - Read the data and form the index
- (ii) Data Cleansing and Conversion – Plot the graph with 5 minutes interval and 1 hour interval, Plot against different factors
- (iii) Data Analysis - Analyze the relationship by plotting the best fit line of the graph
- (iv) Calculate the correlation factor and the equation of the best fit line

12.2.1 Data Cleansing and Conversion

Data collected from the PV Inverter and battery inverter (Figure 13-1) were recorded in the data. The data was cleansed and filtered by a process called data cleansing to ensure that there were no invalid data and the data should be correct and accuracy.



Figure 12-2 The PV Inverter and battery inverter in of the PV System

In this step, invalid or corrupted data were detected, corrected, or even removed from a

database. This step was necessary and importance before data analysis was carried out. Data cleansing was performed both manually and with the assistance of ICT technologies. An application called MATLAB was used. Such application could check the data with a variety of rules and procedures. When two sources of raw data were combined, the process of data cleansing was even more important for preparing consistent sets of data in the system. Any inconsistent data were detected or removed.

The raw data sets collected by HKO and CLP were classified into different sources. Then the data set was transformed and standardized from different source types to MAT file by the MATLAB application. A data filtering function was included in the program to filter the corrupted data automatically. A checksum was used to verify if there was any missing value in the whole data sets. Using MATLAB program could speed up the process of data cleansing and data capture for next step. The check sum verified the accuracy of the data.

The raw data sets were separated into different types according to the sources. The data was filtered and classified into different sub group by clustering technique. For those raw data collected from the Hong Kong Observatory, as the data time interval is much finer, the data was converted into minute classified samples.

After choosing the two parameters from the processed data, the two factors were input into an Excel spreadsheet. The data were indexed by every minute. The invalid data was deleted. Then the daily data was produced in conversion spreadsheet and a summary of that month was generated.

12.2.2 Data Analysis

Three sets of graph were generated, namely (1) Daily chart with 5 minutes interval; (2) Daily chart with hourly interval and (3) Monthly chart with daily interval. The two parameters were plotted for finding out the relationship among the parameters. The best fit line of the graphs was plotted for analyzing the data relationships. The correlation factor and the equation were then determined as the result output.

The correlation factor was a measure of the association between two variables which indicate the degree of association of the two parameters. The correlation factor could range from -1.0 to +1.0. If the values are highly associated, the correlation factor should be close to +1.0 or -1.0, or otherwise should be close to zero. In this project, the correlation factor R^2 was generated by the Excel function automatically. It was the indicator to classify the relationship of the parameters.

Correlation Factor R^2	Relationship of the parameters
1	Perfect correlated
0.7-0.9	Strong relationship
0.4-0.6	Medium relationship
0.1-0.3	Weak relationship
0	Not correlated

Table 12-1 Correlation Factor mapping with corresponding relationship

12.3 Data mining and relationship building

This project aimed to derive a mathematical model to relate different parameters such as power output, Battery State of Charge (SOC), loading and environmental condition and so on. The charts and graphs were plotted to summarize the system performance under different local environmental situations. The mathematic modules were investigated. The data sets were expressed by the equations of the best fit lines. The correlation factors were calculated and was used to determine if the relationships of the environmental factors such as the outputs of the system and system efficiency.

12.4 Gaps between the expected results and actual results

The differences between the real operation and theoretical situation were investigated. The power available at the output of photovoltaic (PV) cells kept the charging process dominated with Solar Radiation and ambient temperature as the current-voltage characteristic of the PV cells were non-linear. The factors such as humidity and wind speed were also related to the ambient temperature. On the other hand, the global solar radiation was also composited by direct and diffuse solar radiation. The rainfall was considered as a positive factor for PV operation as raining helps to self-clean the panels and help to reduce the dirt on the surface. Therefore, the PV panels can capture more solar radiation and minimize the shading effect.

The entire environmental factors were inter-related and were all important to the output and efficiency of the PV system. The hypothesis was supported by theories and simulations.

12.5 Results

12.5.1 SOC and ambient temperature

The relationships of the Battery of Stage of Charger (SOC) and ambient temperature were very weak. The correlation factor was 0.0965., almost zero. The graph plotted with the battery

SOC against the ambient temperature in Figure 12-2 showed that the data are concentrated within a region from 20°C to 30°C. Since the temperature variation was not significant, the PV output was not affected by this parameter. According to some overseas researches about the PV output and the temperature, the temperature difference in a day could be more than 20°C and ambient temperature could reach at 60°C-70°C. In those cases, the output of the PV could significantly decrease as the temperature of the PV module was very high. Therefore, the temperature factor is not the dominated factor the PV output in the typical environment in Hong Kong.

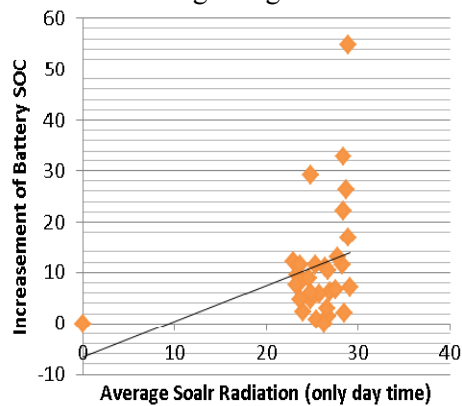

$$Y = 0.7029x - 6.5783; R^2 = 0.0965$$

(Data collected in May, 2011)

Figure 12-3 Battery SOC against ambient temperature

12.5.2 SOC and wind speed

The relationship of the Stage of Charge (SOC) and wind speed was also very weak, or even weaker than that of the ambient temperature. The correlation factor was only 0.0178. According to Figure 12-3, the chart showed the graph of the Battery SOC against mean value of the wind speed. Therefore, the wind speed was also not a dominated factor which affects output of the PV system installed in Hong Kong.

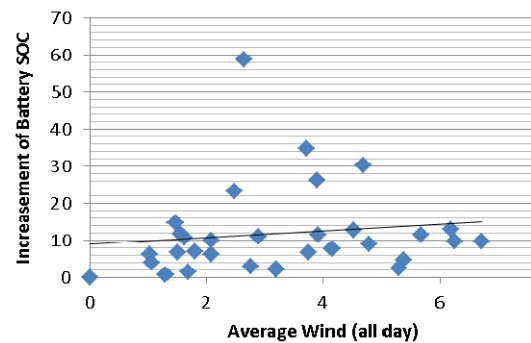

$$Y = 0.8899x + 8.9942; R^2 = 0.0178$$

Figure 12-4 Pot Battery SOC against Average Wind Speed of May

12.5.3 SOC and solar radiation (Before data filtering)

To study the relationships between solar radiation and the battery State of Charge (SOC),

the increments of the Battery SOC against the solar radiation were plotted for every hour from May to September 2010. Without performing appropriate data filtering, it was very hard to analyze the relationship. SOC was just one way to measure the PV output. However, it also depends on other factors such as the solar radiation, initial SOC and the loading demand....etc.

According to Figure 12-4, the Battery SOC increments were plotted against the average solar radiation in May 2010 without any data filtering. The correlation factor was only 0.159. and it was difficult to conclude any strong correlations between the parameters.

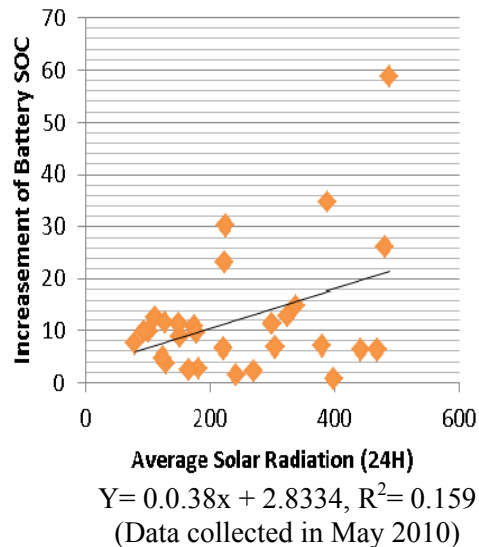

Figure 12-5 Battery SOC increment against the average solar radiation

12.5.4 SOC and solar radiation (After data filtering)

In order to obtain a better correlation, the data are filtered and the results were shown on Figure 12-5. In those days when the Battery SOC was charged up to more than 95% of its full capacity, the batteries were not be able to be further charged at the noon time. In this case the capacity of the battery is the limiting factor and it should be increased in order to provide more rooms for further charging. After filtering those data with the battery SOC exceeded 95%, the relationship between solar radiation and the battery SOC was almost linear. The correlation factor was 0.75 which indicated that their correlations were strong.

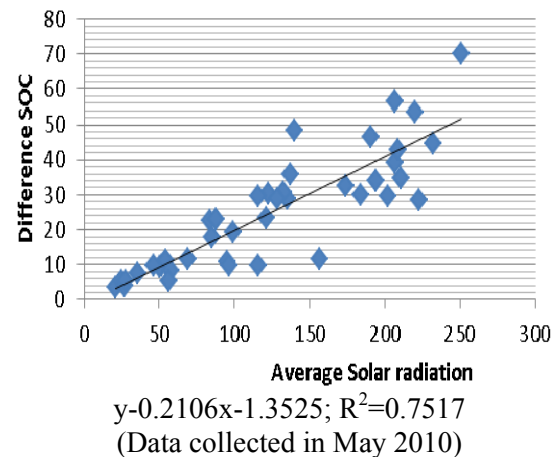

Figure 12-6 Battery SOC increment against the average solar radiation with clustering

12.5.5 Inverter output and Solar Radiation

Since it was discovered that the correlation of the Battery SOC with the parameters such as wind speed and ambient temperature were not strong, we mainly focused on the study on of the output power of the inverter and the solar radiation.

The raw data collected from the Hong Kong Observatory were used to provide information about the direct and diffuse solar radiation.

The chart on Figure 12-6 shows that the relationship of the PV inverter output (P_{ac}) and mean diffuse and mean direct solar radiation recorded in May 2010 was very coherent. In early May 2010 when the battery was fully charged, the increment of P_{ac} was significant even when the direct solar radiation was increasing. The peak of the direct solar radiation was also the peak of the P_{ac} . The direct solar radiation was the dominating factor to the inverter output.

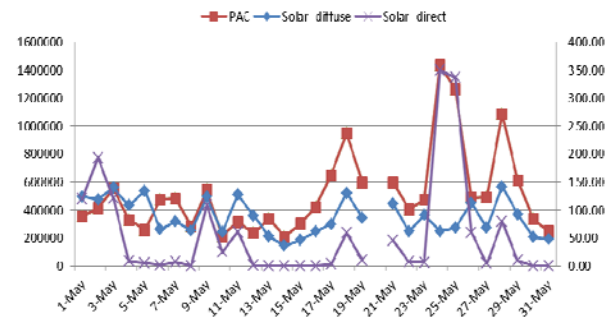

Figure 12-7 Relationship of the Pac and mean Diffuse and Direct Solar Radiation of May

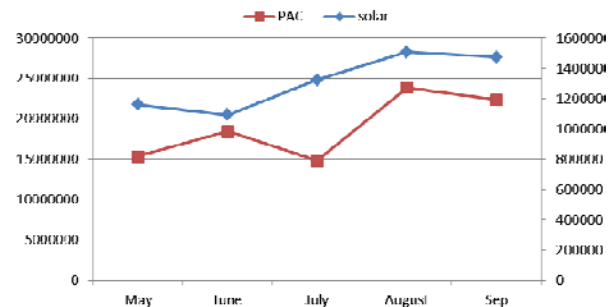

Figure 12-8 Chart of PV output P_{ac} and Global Solar Radiation of May

12.5.6 Effect of direct and diffuse sunlight

Figure 12-7 shows the PV output (P_{ac}) and the global solar radiation in May 2010. It was discovered that P_{ac} did not follow the trend of global solar radiation. In other words, the solar radiation was not fully converted to electrical energy. Apart from the limitation of the battery capacity, the ratio of direct and diffuse solar

radiation was also a factor. In order to show this effect, the ratio of diffuse and direct solar radiation was calculated for further data analysis.

Figure 12-8 shows the clustering index result of the ratio. The data sets were separated into 3 clusters. The ratio less than 50 was classified as Group A (the cluster in red).

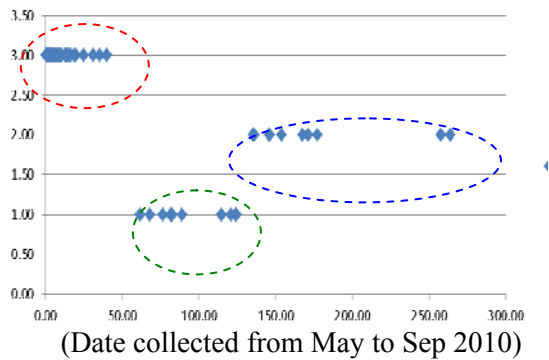

Figure 12-9 Ratio of diffuse and direct solar radiation with different weather type clusters

The ratio in between 50 to 150 was classified as Group B (the cluster in green). The remaining data were classified as Group C (the cluster in blue). These groups are corresponding to different weather conditions, namely sunny day, partly cloudy day and cloudy day respectively. According to Figure 12-9, the P_{ac} exceed 500kW was Group A while the P_{ac} below 500kW were Group B and Group C.

Group	Weather condition	Cluster colour
A	Sunny day	Red
B	Partly cloudy day	Green
C	Cloudy day	Blue

Table 12-2 Classification of clusters

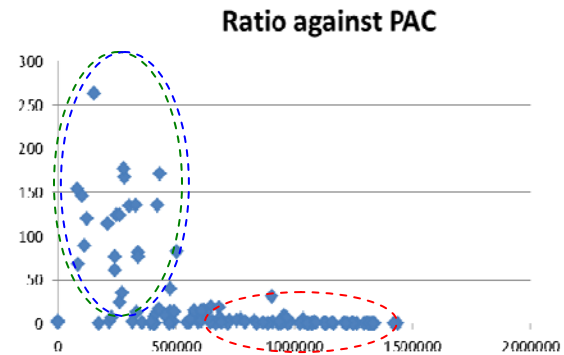

Figure 12-10 Scatter chart of the PV output P_{ac} and ratio of diffuse and direct solar radiation

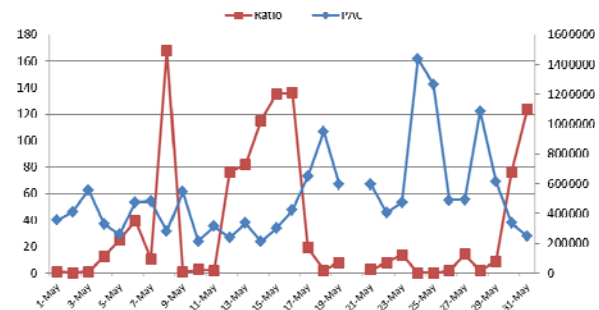

Figure 12-11 Relationship of the PV output P_{ac} and the ratio of diffuse and direct solar radiation

Figure 12-10 shows the relationship of the PV output P_{ac} and ratio of diffuse and direct solar radiation in May 2010. They were inversely related. In short, this analysis showed that the inverter output P_{ac} was strongly correlated to the solar radiation. The average correlation factor from May to Sep 2010 was 0.989.

12.6 Conclusions

The raw data collected from the photovoltaic system in the Town Island provided by CLP Power and the weather data provided by Hong Kong Observatory were used to investigate the relationship among various environmental factors such as solar radiation, wind speed, ambient temperature...etc. The PV output of the system in terms of SOC and inverter output were the dominating factors which correlate to solar radiation. The direct solar radiation also plays the key role of the system output and efficiency of the system. The ambient temperature and wind speed were the less significant factors. It was discovered that the major localized environmental effect affecting the system was the solar radiation. When the battery capacity was fully charged, the most effective way to improve the system efficiency is by increasing the battery capacity.

Reference

- (1) S.R. Wenham, M.A. Green, M.E. Watt and R.Corkish, "The Characteristic of Sunlight," in Applied Photovoltaics 2nd ed. UK and USA, ARC Centre for Advanced Silicon Photovoltaics and Photonics, pp. 3-25
- (2) M. Pagliaro, G.Palmisano and R.Ciriminna, "Inorganic Thin Films", in Flexible Solar Cells Germany,Wiley-VCH, pp. 55-82
- (3) R.A. Messenger and J. Ventre, "Standalone PV Systems" in Photovoltaics Systems Engineering 3rd ed. USA, pp. 271-282
- (4) S.S.Hegedus and A. Luque, "Status, Trends, Challenges and the Bright Future of Solar Electricity from Photovoltaics" (2003), pp. 1-43, in A. Luque and S.S. Hegedus (eds.), Handbook of Photovoltaic Science and Engineering, Chichester:John Wiley & Sons.
- (5) S.S.Hegedus and A. Luque, "Thin- Film silicon Solar Cells", pp307-357, in Handbook of Photovoltaics Sience and Engineering, Chichester:John Wiley & Sons
- (6) S.R.Wenham, M.A.Green,M.E.Watt and R.Corkish, "Amorphous Silicon", pp34-35, in Applied Photovoltaics p34-35
- (7) National Renewable Energy Laboratory <http://www.nrel.gov/gis/>

13 Case – Hong Kong Schools Solar Education Programme

Dr. K.H. Lam

Department of Electrical and Electronic Engineering, The University of Hong Kong

This case study assesses the contribution of the extensive photovoltaic (PV) arrays installed on the Ma Wan School to meet 10% of the School's annual electricity demand based on the extensively monitored data and compared with the project inception simulation studies. The project — jointly funded by the HK Government and the research institute of the local utility — was the pilot for small-scale grid-connection technical and non-technical issues and also identified the need for specially trained PV installation engineers.



Dr. K.H. Lam measured a PV Panel in HKU

13.1 Introduction – MaWan School BIPV project

The Building Integrated Photovoltaic (BIPV) project at the CCC KeiWai MaWan Primary School (hereafter referred as the MaWan School) is a research project funded by the Hong Kong government Innovation and Technology Fund (ITF) and the CLP Research Institute (CLPRI). It commenced on the 1st February 2001 and finished in September 2005. The author acted as the Project Electrical Engineer and was responsible for the electrical design, management and monitoring of the installation of the 3 BIPV systems. The project comprises three different kinds of commercial PV technology and therefore can provide a

platform for comparing different PV technologies' performance in Hong Kong. Another essential element of the project is the sophisticated and comprehensive monitoring system that can acquire the data automatically at high accuracy every 30 seconds. The ranges in PV technology, the superiority of the data acquisition (DAQ) system as well as the different integration methods applied to the PV make possible this project to serve as a case study. The following section will describe the settings of and data available from the BIPV project.

13.1.1 Background of the project

In February 2001, the PV Research Group at the University of Hong Kong (HKUPV) won funding from the ITF and the CLPRI for a project titled the "HK Schools Solar Education Programme". This project aimed at community education, demonstration; and research on the PV technology, building integration and grid-connection issues. It focused on energy efficiency as well as RE generation. The rationale behind it was that the small yield of PV is more useful when allied to maximising energy efficiency with sophisticated control. Furthermore, electrical transducers of good accuracy have been installed to monitor the individual strings as well as for each BIPV subsystem. This allows the collection of detailed and accurate data on the performance of the three different PV technologies integrated to the building by different means.

The schools in Hong Kong can be built at a maximum of 8 storeys above ground level. This offers horizontal layouts in contrast to the normal vertical bias of most sectors in the dense urban context and thus has a larger roof area to gross floor area ratio for optimised PV applications. At that time the design of all public or subsidised schools in Hong Kong were overseen by the Architectural Services Department (ASD); and then operated by the school operator under the supervision of the Education Bureau (EDB). This project thus could only be accomplished through the help of the two government bodies. In late 2001, a new school to be built was selected by the EDB (formerly the Education Department) for the project. Its location is on an outlying island called MaWan in Hong Kong. The exact latitude of the school is $22^{\circ}21'03''$ N and longitude is $114^{\circ}03'35''$ E. This accurate positioning of the PV installation is required for calculating the Air Mass (AM) and solar path for estimating the shadowing effect from nearby buildings.

In early 2002, the MaWan School was at the tender stage. From the tendering documents prepared by the contractors, the local industry demonstrated that there was generally a lack of understanding on BIPV systems. The long learning curve and local experience have been reported by Close et al. [1] and Lam et al. [2] respectively. The Project Architect from ASD handled these difficulties with great patience

and integrated the HKUPV design intent into his school. The complete school design had already

been finished by the end of 2001. A model was built showing the form of the school as follow:



Figure 13-1 The model of the MaWan School designed by ASD.

The school consists of three main building blocks: the classroom block with seven floors on the North, the hall block on the East and the special block on the South. A floor plan below shows the arrangement of the three blocks. Originally there were four BIPV systems designed to be built on the envelope of the school building. Due to the limitation of funding resources, the PV facade was subsequently removed from the design. Only three different BIPV systems were retained.

They utilised contemporary PV technology of Copper Indium Diselenide (CIS) modules, polycrystalline silicon (p-Si) embedded in glass and tandem junction amorphous silicon (a-Si) modules. Besides different PV technologies adopted, the methods of integration to the building are different and will be explained in section 15.2.

The BIPV systems at MaWan School were scheduled to completion by summer 2003.

However, due to the sub-contractors' "lack of familiarity", the school construction finished late (by 3 months) and the PV installations, in phases, later still (9 months) while the monitoring system for data acquisition was not fully completed until August 2004 with extra input from the HKUPV team. The detailed arrangement of each BIPV system is explained in section 15.2.

13.1.2 Monitoring system

The MaWan School BIPV project is mainly a research project and hence the data collection is of crucial importance. Sophisticated monitoring system is in place to acquire accurate data at 30-second interval. This section describes the details of hardware and software constituting the monitoring system.

In order to record the data of different PV systems at different locations (even within the same building complex), remote monitoring is necessary. Distributed analogue-to-digital (A/D) converters of a reputable brand of data acquisition provider – National Instrument has been chosen for such purpose. Real time data are transferred back to the central monitoring station (CMS) through Local Area Network (LAN). To avoid data loss in event of power or network failure, the network modules are all equipped with built-in Central Processing Unit (CPU) and Random Access Memory (RAM) to store autonomous data-logging programme. When it cannot communicate with the CMS, the

programme embedded can still operate and keep logging data for 2 weeks without interruption. Both the CMS and network modules are supported by Uninterruptible Power Supply (UPS) power to further increase the reliability. The monitoring system comprises of the following components (which are shown in Figure 15-3):

- i) Pyranometer within an accuracy of +/- 1%.
- ii) Voltage transducers within an accuracy of +/- 0.8%.
- iii) Current transducers within an accuracy of +/- 0.5%.
- iv) Power transducers within an accuracy of +/- 0.5%.
- v) 100 ohm Platinum resistance-temperature detectors fully calibrated with length of data cable connecting to the distributed input/output conditioner.
- vi) Distributed analogue-to-digital (A/D) converter to receive analogue signals from the above transducers/detectors and convert to digital signals for passing back to a central monitoring station via LAN cable.
- vii) Central monitoring station to acquire the data from the distributed input/output

conditioners, store the data in the hard-disk and publish the data through the internet.

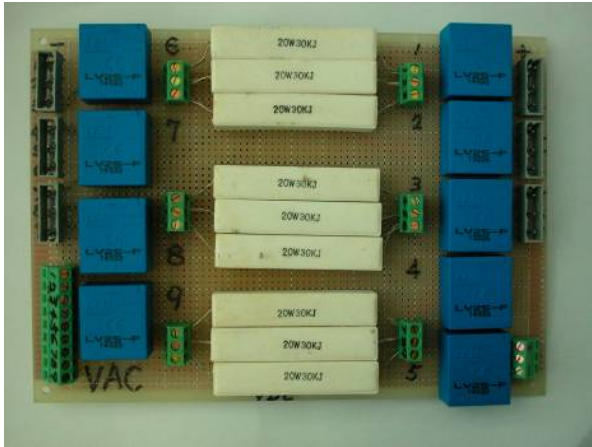

Figure 13-2 High precision voltage and current transducers (LHS)



Figure 13-3 Pyranometer installed on the same plane to PV modules (RHS).

The programming environment for the monitoring system is LabVIEW version 7.1.1 which is the version available at the time of the system being developed. Adopting the same programming platform for the monitoring system and the dynamic model would ensure smooth data transfer and analysis. Again, the programming approach is data-driven and well in-line with the object-oriented programming techniques. This monitoring system was mainly developed by Mr. Huey Pang in conjunction with the author. The structure of the programme is shown in Figure 15-5.

The monitoring system acquires data from the sensors through the distributed A/D converters; then stores and publishes them. Remote control of the system can also be done through the internet. To facilitate education purpose, together with the merit of easy routine checking, instantaneous data are published on website through the internet. A sample of data display is shown below:



Figure 13-4 Web display Instantaneous power output from the School PV systems

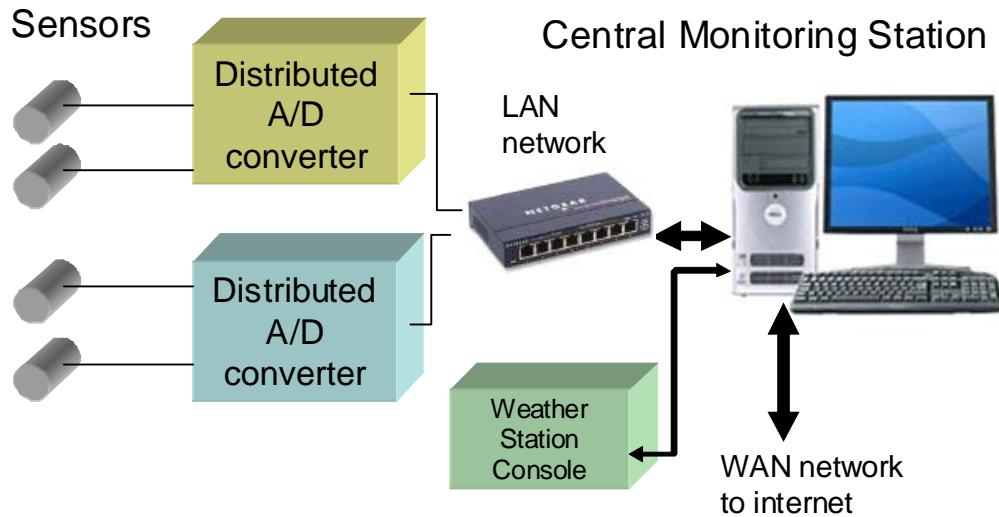

Figure 13-5 The structure of the monitoring system at the MaWan School

13.1.3 Details of data

The two main sets of data to be collected for each PV system are the environmental and electrical parameters:

- Local time stamp: HH:MM:SS
- In-plane global solar irradiance: G_n (Wm^{-2})
- Ambient temperature: ϑ_a ($^{\circ}\text{C}$)
- Wind speed: v (ms^{-1})
- Panel temperature: ϑ_c ($^{\circ}\text{C}$)
- String current of the n^{th} string: I_n (A)
- System voltage of the system: V (V)

- System current of the system: I (A)
- AC power output from the inverter: P (W)

The acquired data are to be appended to the Excel file of the month according to each system. Each row of data are the averaged values of the past 30 seconds, with the times stamp being the time when the data being acquired from the distributed A/D converter. On the first day of each month a new Excel file will be opened at 30 seconds after mid-night.

13.2 Detail settings of BIPV systems

The MaWan School project is the first local school with large-scale BIPV installations. The design and installation were all finished before the Hong Kong Government publication of “Technical Guidelines for Grid Connection of Small Scale Renewable Energy Power Systems (2005 edition)” [3]. In fact, the MaWan School BIPV project is recognised as one of the pioneer projects in Hong Kong and subsequently adopted as one of the working example in the Government technical guidelines 2007 edition (p.27) [4]. The BIPV installation consists of three systems, each on one of the building blocks of the building complex (Figure 15-1). One of the systems is further divided into two sub-systems operating at different voltages. The three systems are:

- I) **Deck-shading** on roof of the classroom block;
- II) **Rooflight** integrated to cover the roof of the staircase in the hall block;
- III) **Canopy** on the roof of the special block.

The completed BIPV installation at MaWan School is shown in the aerial photo taken from the roof of a residential building to the South of the school below. This residential building to its South is casting a shadow onto the BIPV systems in the winter. The dynamic model can accurately predict the time of the shadow.



Figure 13-6 Aerial photo of the completed MaWan School
(Taken from the building to the east of the School)

The three BIPV systems on the three building blocks are numbered from North to South in a clockwise direction. A diagram below is representing the numbering scheme:

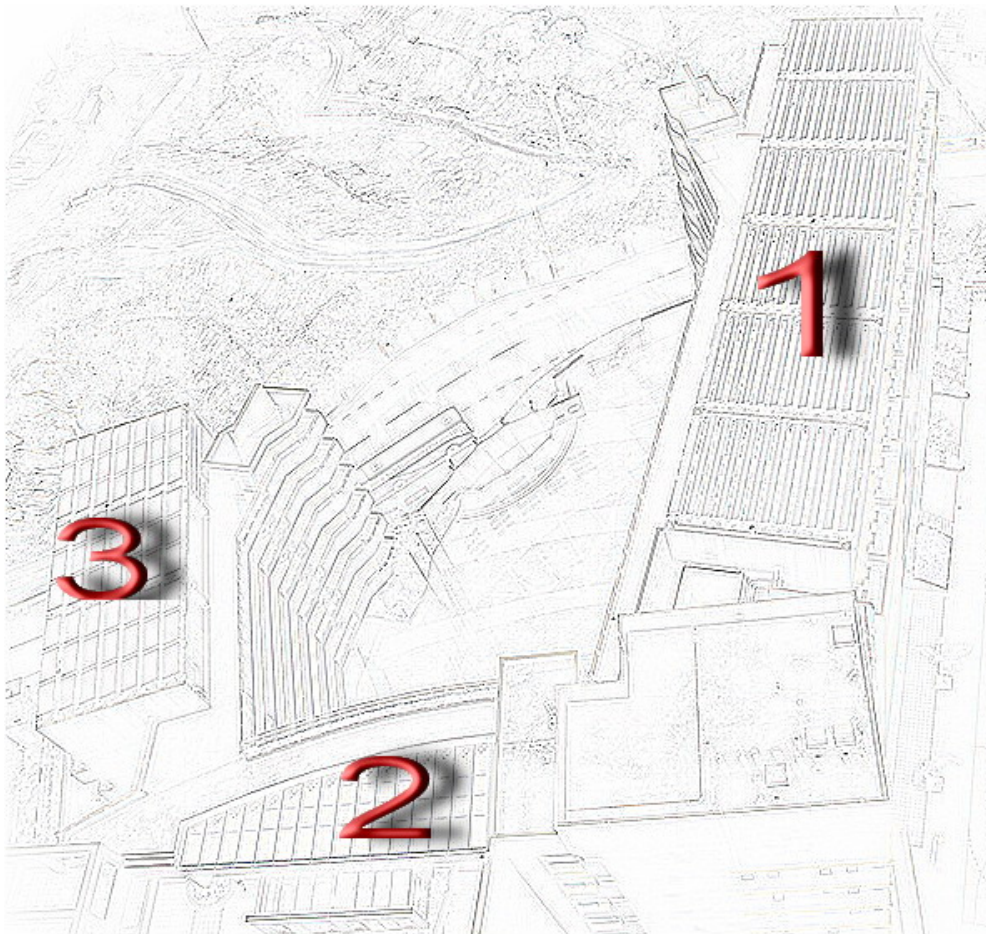

Figure 13-7 Numbering of the three BIPV systems.

The characteristics of the three BIPV systems are summarised in the Table 15-1, while the details of each system is explained in the following sections.

System name	Deck-shading (classroom block)		Rooflight (hall block)	Canopy (special block)
PV technology	Copper Indium Diselenide (CIS)		Poly-crystalline silicon (p-Si)	Amorphous silicon (a-Si)
System No.	Sub-system 1A	Sub-system 1B	2	3
No. of inverters	1	6	2	3
No. of strings	24	12	1	7
No. of panels per string	15	5	24-28	3
String V_{DC}	249	83	294-319	204
Sub-System rated power	14.4kW	2.4 kW	2.0kW	2.4kW
Total no. of panels	360	360	52	63
System rated power	28.8kW		4.0kW	7.2kW

Table 13-1 Characteristics of the 3 BIPV systems at MaWan School.

13.2.1 Deck-shading (system 1)

Deck-shading, as its name implies, is designed to shade the roof of the classroom block to minimize solar heat gain to further maximise the functionality of the BIPV system. It is utilising a newly commercialised (at the time of writing the specifications) technology of Copper Indium

Diselenide (CIS). By the time of its completion in August 2004, it is the largest CIS BIPV system in Asia. The total rated power of the entire system is 28.8kW with 720 numbers of a proprietary CIS panels from Siemens Solar Industries that is then acquired by Shell to become the Shell Solar Industries (SSI).



Figure 13-8 Completed deck-shading BIPV system.

The whole deck-shading system was divided into 6 bays according to the structural support from left (west) to right (east). It had been specially designed for off-site prefabrication and mass-production. The panel arrangement also suits the standard Hong Kong School Planning Grid (7.5mx9.6m). The deck-shading was installed on the roof relatively free from shadow and at a tilt angle of 20°. This is the optimised angle for the whole year. It is further divided into two sub-systems (Figure 15-9). The first 3 bays on the west were named as System 1A while the last 3 bays on the east were named as System 1B. Each bay has 12 “double strings” – with two rows of strings in each double string.

Each string consisted of 5 modules; therefore each bay has a total of $24 \times 5 = 120$ modules. String voltage equals to $16.6\text{V} \times 5 = 83\text{V}$.

For system 1A, 24 strings were connected in parallel within a bay to form an array, then bay 1, 2 and 3 were connected in series to form a high voltage system. The system voltage is $83\text{V} \times 3 = 249\text{V}$ and the system peak power equals to $40\text{W} \times 120 \times 3 = 14.4\text{kW}$. For system 1B:1-6, 12 strings were connected in parallel with a bay to form a low voltage system, therefore the system voltage is 83V and the system peak power equals to $40\text{W} \times 60 = 2.4\text{kW}$.

World” December 2005 edition, which is shown in Figure 15-11.

13.2.2 Rooflight (system 2)

The rooflight is the real integration of PV system into the building envelope. The design of the rooflight combines a range of customised PV modules to suit the curved radius of the rooflight. The PV modules are comprising of the most popular type of PV cells, each of 150 x 150mm poly-crystalline silicon cells, embedded in glass layers. The PV cells in this system are embedded between heat strengthened tempered glass layers within Ethylene Vinyl Acetate (EVA) compound, with a minimum 50mm border from glass edge to cell. The top glass layer was low-iron oxide content complying with EN 572-2 with anti-reflection coating to maximise the light capture.

The rooflight is divided into two subsystems of 2A and 2B. This is to cater for the winter shadows casting onto the southern part of the array from nearby buildings. When system 2A is under shadow, system 2B remains unaffected.

The rooflight is covering the stair-case of the hall block of the school, and casting a nice pattern on the stair under the sun. It is realising the multi-functions of a BIPV system while maintaining an appealing architectural feature. This appealing feature was selected as the cover page for the magazine “Renewable Energy



Figure 13-9 Sub-division of system 2.

13.2.3 Canopy (system 3)

The Canopy was originally designed to hang over the South-facing entrance and windows. Subsequent school design changes relocated the South-facing entrance to the West. The PV canopy therefore was relocated to the roof of the special block but retaining the name to signify its original design feature. Similar to the Deck-shading, the BIPV arrangement suits the standard Hong Kong School Planning Grid (7.5m x 9.6m). The whole system was divided into 3 bays according to the structural support from west to east. Each bay has 7 rows of strings while each row consisted of 3 modules; therefore each bay has a total of $7 \times 3 = 21$ modules. String voltage equals to $68V \times 3 = 204V$ and the system peak power equals to $114.2W \times 21 = 2.4kW$.

The PV modules are utilising the second generation tandem junction a-Si technology. Four standard raw modules laminated together to make a larger heat strengthened, tempered glass plates in the size of 2400 x 1200mm. Although designed with different supporting structure as compared with that of Deck-shading, the contractor installed similar steel structure for the two systems to minimise the costs.

The Canopy system is on the Special block within the school building complex, which is situated on the South of the school premises (Figure 15-7). Due to its proximity to nearby

residential building, it is in the building's shadow when the sun is low in the sky. Special design consideration is therefore needed for this system to optimise the energy yield from the PV systems. The constructed tilt angle of the PV arrays for Canopy is therefore 10° facing due South (aligning to the building arrangement).



Figure 13-10 Three bays of Canopy system to suit the standard HK School Planning Grid.

13.3 Summary of the BIPV system performance

Upon completion of the sophisticated monitoring system for data acquisition at MaWan School in August 2004, the detail environmental and electrical parameters are being recorded at 30-second intervals. A large amount of data is then available for analysis. The following are the summary of the BIPV systems electrical performance at MaWan School.

The major function of the BIPV system is to generate electricity. The monthly electrical energy output from the three systems is found by summing up the 30-second interval power output from the systems according to equation (15.1), and the results are summarised in table 15-2. The percentage contribution of the BIPV systems to the total school electricity consumption is also given to demonstrate its significance. It is shown that about 8% of the

total electricity requirements within a building complex of 5 to 7 floors can be provided by BIPV systems covering around 40% of the total roof areas. Close et al. [5] discuss in detail the potential contribution of PV as a distributed generation to a building by using MaWan School BIPV project as an example.

Energy yield is found by: $E = \sum P\Delta t$

Year 05-06	Jun-Aug	Sep-Nov	Dec-Feb	Mar-May	Jun-Aug
Solar resources (kWhm ⁻²)	374.25	349.73	264.52	296.21	366.64
Total PV yield (kWhm ⁻²)	10865	9879	7439	7728	10293
School electricity used (kWhm ⁻²)	124465	125799	67569	112550	138420
Total PV (% of electricity bill)	8.73 %	7.85 %	11.01 %	6.87 %	7.43 %

Table 13-2 BIPV energy output in relation to solar radiation and electricity consumption

The important performance indicator final yield is also calculated according to IEC 61724 [6]. Final yield (Y_f) represents the final energy delivered by the PV system as a result of the solar irradiance received and it is site-specific. This indicator can be adopted for comparison of different PV arrays installed at the same physical conditions. Caution must be taken in directly comparing the numerical values of final yield because shading, tilt angle and other

factors could all affect it. The total BIPV daily final yield as well as that of individual system is shown in table 15-3.

Besides final yield, the performance ratio is very useful in indicating the proportion of actual output to that of ideal output. It is independent of the solar resources and can reflect the degree of success of the design and installation of such system in view of the electricity generation.

The following table shows the performance ratio of each system in different seasons of year

2005-06.

Year 05-06 (in kWhd ¹ /kW)	Jun-Aug	Sep-Nov	Dec-Feb	Mar-May	Jun-Aug
System 1	2.75	2.74	2.22	2.07 [†]	2.70
System 2	3.09	2.31	1.44*	2.09	2.00 [†]
System 3	3.68	2.82	1.80*	2.46	3.90
Total BIPV	2.95	2.71	2.066*	2.14	2.85

*exceptional results due to systems under shadow of nearby buildings;

[†]system output affected by broken PV strings due to loose contact in combiner box.

Table 13-3 Summary of daily final yield

Year 05-06	Jun-Aug	Sep-Nov	Dec-Feb	Mar-May	Jun-Aug
System 1	0.6896	0.6188	0.6274	0.7018	0.6861
System 2	1.2075*	0.9789	0.9888	1.1431*	0.8161
System 3	0.9586	0.8907	0.8500	0.9981	0.9909

*erroneous results due to pyranometer under partial shadow of nearby structure.

Table 13-4 Summary of performance ratio of the 3 BIPV systems

In general, the final yields from the respective BIPV systems are well in line with the prediction, when we take into consideration the

decline in solar radiation we received in recent years. Together with the less than expected school electricity consumption, the PV systems

generated 8.0% of the total school electricity consumption during the academic year of 2005-06. This is in good agreement with the prediction of PV providing 9.04% of the school energy load [5].

The daily final yields are indicating the actual performance of the individual systems. From Table 13-2, it is clear that Hong Kong's solar resources demonstrate a clear seasonal effect: the solar irradiance is about 23-26% higher in both summer and autumn as compared with either spring or winter. System 2 (p-Si) was installed as rooflight and the panels are therefore horizontal without any tilt. This explains then why the p-Si rooflight is generating much higher yield during summer time than other seasons. Since it is serving as an architectural component, its electricity yield is compromised to certain extent.

System 1 (CIS) was installed on the roof relatively free from shadow and at a tilt angle of 20°. This is the optimised angle for the whole year. For both summer and autumn in 2005, its daily final yield is almost identical, when the solar resources during summer time in Hong Kong were 6% better than autumn. Its system performance ratio was consistently 0.69 and 0.72 during summer and spring. But in autumn and winter time, it was lowered to 0.62 and 0.63 due to a partial mutual shading.

System 3 (a-Si) was tilted at 10° to cater for its being shaded by nearby building during winter

time. It delivered a daily final yield peaked at 3.68 kWh/kW during summer time. This higher than expected yield shows that a-Si is less affected by the hot temperature conditions (when its panel temperature was around 65°C at noon) and can utilise better the solar resources in sub-tropical/tropical climate. This is mainly due to the lower temperature co-efficient of the a-Si technology. Also, its performance ratio can be maintained at 0.85 to 1.0 throughout the year. Another obvious seasonal effect is that a-Si systems can perform closer to its rated values (that is with performance ratio near to unity) during summer time and then drop to 0.85 during winter.

All in all, the 3 commercial technologies are performing well in the MaWan primary school. Besides generating electricity, they are also serving as architectural components, as well as exhibiting to the schoolchildren how renewable energy could be incorporated into their education as well as daily life. Both p-Si and a-Si are performing very closely as predicted. The CIS systems are performing to certain extent lower than expected. Besides some non-technical reasons like that of poor quality of installation, the newly (by the time when they were purchased in 2002) commercialised CIS panels were not as good as they were promised. More recent commercial CIS modules were subsequently tested and the performance was found to be improving. The discussion on the

CIS degradation issues was previously reported by the author [7].

13.4 Conclusion

The Ma Wan Primary School, HK, has received comprehensive local media attention as well as HK Government and Utilities' scrutiny. With greater focus on energy conservation through the education programme it is anticipated that savings during school and out-of school hours can be achieved while maintaining comfort conditions. Even on present evidence, target 10% of the School's annual electricity consumption from PV generated electricity is achievable, suggesting the target could be raised to 15%. Educators acknowledge the very great educational potential that PV installations offer for general science education with more opportunities for hands-on experience and project-based learning together with promoting skills in Information Technology. A widespread HK Schools Programme would not only benefit the school children and teachers but school PV installations can provide the facilities on which to train installation and maintenance engineers and also carry out small-scale energy audits that would raise their competency and effectiveness in future installations.

References

[1] Close, J., Lam, K.H., Pang, H., and Wong, F. (2003), "Building Integrated Photovoltaics in

HK: Big Potential but a Long Learning Curve", The 6th International Conference on Advances in Power System Control, Operation and Management, Vol. 1, Hong Kong.

[2] Lam, K.H., Close, J., and Pang, H. (2004), "Local experience in designing, testing and commissioning grid-connected PV systems in Hong Kong", Proceedings of the 8th China PV Conference, Shengzhen, China.

[3] Electrical and Mechanical Services Department HKSAR (2005), Technical Guidelines on Grid Connection of Small Scale Renewable Energy Power Systems, March, Hong Kong.

[4] Electrical and Mechanical Services Department HKSAR (2007), Technical Guidelines on Grid Connection of Renewable Energy Power Systems 2007 edition, July, Hong Kong.

[5] Close, J., Pang, H., Lam, K.H., and Li, T. (2006), "10% from renewables? The potential contribution from an HK schools PV installation programme", Renewable Energy, Vol. 31, pp. 1665-1672.

[6] IEC 61724 (1998), Photovoltaic System Performance Monitoring - Guidelines for Measurement, Data Exchange and Analysis, International Electrotechnical Commission.

[7] Lam, K.H., Close, J., and Durisch, W. (2004), "Modelling and Degradation Study on a Copper Indium Diselenide Module", Solar Energy, Vol. 77, pp. 121-127.

not **The End**

This is the end of this book, but not the end of our actions. Different professionals including engineers, researchers, environmentalist, manufacturers, and consultants in Hong Kong, China and all over the world will continue to contribute our expertises in to discover new clean energy and technologies for environment improvement. The environmental pollution and climate change problems have already created many visible and irrecoverable impacts to our earth. We need to work hard together to keep our blue planets always green and bright for our next generations.



Index

A

Amorphous Silicon, 85
Architectural Services Department, 176

B

bathocuproine, 91
battery energy storage system, 111
battery EV, 94
Battery technology, 162
BIPV, 175
blade subtend-angle, 77
Building Integrated Photovoltaic, 175
Bulk Generation, 46
bulk-heterojunction polymer, 89

C

Cadmium-Telluride, 84
Capacity planning, 161
Chlorofluorocarbons, 130
Cloud computing, 119
CLP Power, 154
CLP Research Institute, 175
Compressive sensing, 56
Computer Recycling Program, 124
copper (II) phthalocyanine, 91
Copper Indium Diselenide, 178
Copper-Indium-Selenide, 84

D

Dawn Island, 154
Deck-shading, 185
demand-side management, 48
Dematerialization, 116
Deuterium, 129

Diamagnetic effect, 129
Distributed Energy Resources, 49
dye-sensitized solar cells, 84

E

EICC, 123
electric variable transmission, 96
Electronics Industry Code of Conduct, 123
Ethylene Vinyl Acetate, 187

F

Fleet Management System, 118
flywheel, 127
fuel cell EV, 94

G

Generation dispatch, 48

H

HAWT, 74
Heterogeneous Home Area Network, 59
Heterogeneous network platform, 55
horizontal axis wind turbine, 74
hybrid EV, 94

I

Innovation and Technology Fund, 175
International Research Centre for Electric Vehicles, 103
IRCEV, 103

L

Levitated dipole experiment, 130

M

Magnetic refrigeration, 130
magnetocaloric effect, 131
Molybdenum, 86

N

nuclear fusion, 130

O

Organic Thin Film Solar Cell, 87

P

Pervasive Service-Oriented Network, 55
Phasor measurement unit, 69
PHEV, 97, 99, 110
Photochemical thin film solar cells, 86
photovoltaic, 157
photovoltaics, 83
plasmonic resonance frequency, 90
plug-in hybrid EV, 96
poly-crystalline silicon, 178
Polymer solar cells, 87
Prius, 109

R

REEV, 97, 99
Reference Solar Spectral Irradiance, 89
refrigeration, 130

rooflight, 187

S

SANET, 42, 43, 47
SCADA, 48, 69, 117
Schottky contact, 85
Seabed investigation, 157
Service-oriented network, 55
Smart Grid, 45
solidity, 79
subtend-angle, 78
SULEVs, 96
Superconductor bearings, 129
super-ultra-low-emission vehicles, 108
surface plasmonic effect, 90

T

Thin Film Chalcogenide, 85
tip speed ratio, 77
titanium dioxide, 86
Town Island, 154

V

variable-voltage variable-frequency, 103
Virtualization, 119

W

Wide-Area Measurement System, 48
Wind turbines, 127

14 Acknowledgements

We would like to acknowledge the following persons and organisations for their contributions to this book.

For the contributions of the book prefaces

- ❖ Mr. YAU Tang Wah, Edward, JP, Secretary for the Environment, HKSAR Government
- ❖ Prof. TSUI Lap Chee, Vice Chancellor, The University of Hong Kong
- ❖ Prof. Paul TAM, Pro- Vice Chancellor, The University of Hong Kong
- ❖ Prof. W.C. CHEW, Dean of Engineering, The University of Hong Kong
- ❖ Ir. Dr. CHAN Fuk Cheung, Senior Vice-President, Hong Kong Institution of Engineers

For other contributions

- ❖ CLP Power Limited
- ❖ CLP Research Institute
- ❖ Creative Commons
- ❖ Hong Kong Productivity Council
- ❖ Innovation and Technology Fund, Innovation and Technology Commission
- ❖ Knowledge Exchange Fund, University Grant Committee
- ❖ Research Grant Council of Hong Kong (HKU7179/07E).
- ❖ Members of the Initiative on Clean Energy and Environment (ICEE)
- ❖ Members of the International Research Centre for Electric Vehicles (IRCEV)
- ❖ Mr. Eric H.H. AU YEUNG
- ❖ Dr. Josie CLOSE, MBE
- ❖ Mr. Ken K.Y. LAW
- ❖ Miss Esther WONG
- ❖ Ms. Lisa L. XU

This book have introduced to readers many brilliant ideas and advanced technologies on the generation and utilization of energy, including the development of smart grid, renewable energy and electric vehicles. I hope that these ideas and technologies can be put to good use for the benefit of our environment and society.

Mr. YAU Tang Wah, Edward, JP
Secretary for the Environment, HKSAR

This book is published on the International Mother Earth Day, 22 Apr 2011 and is timely to demonstrate fully the awareness of the Hong Kong Engineers and Professionals in combating the climate change. It also exhibits the good work of the contributing authors. Finally, I recommend this book to all the Hong Kong Engineers and Professionals and it is my wish that the book would inspire further engineering and technology advancement in the coming future.

Ir. Dr. Chan Fuk Cheung
Senior Vice-President,
The Hong Kong Institution of Engineers

As the University celebrates its centenary, Knowledge Exchange Projects like this one remind us of the responsibilities that come with the benefits of IT advances and globalisation, and of the continuing importance of producing knowledge, of using it wisely, and sharing it widely. As such, it is outstanding example of the 'Knowledge, Heritage and Service' that HKU stands for, and my warmest congratulations to all those who have contributed to, or are taking part in, such a timely and worthy project.

Professor Lap-Chee Tsui
Vice Chancellor, The University of Hong Kong

Sustainable development has attracted the attention of scientists, engineers, academics, politicians and the wider community around the globe. Clean Energy and Environment is not a dream but a target that we have to strive for our sustainable future. This book shares the knowledge and technologies developed by professors, researchers and alumni of the University of Hong Kong. It is aimed that this book can catalyze the knowledge exchange and adoptions of more clean energies and green technologies for a better environment for our next generation.

Dr. Wilton Fok
The Editor

Published by:

Faculty of Engineering
The University of Hong Kong



<http://engg.hku.hk>



Initiative on Clean Energy and Environment
The University of Hong Kong



<http://icee.hku.hk>



9789881504517